

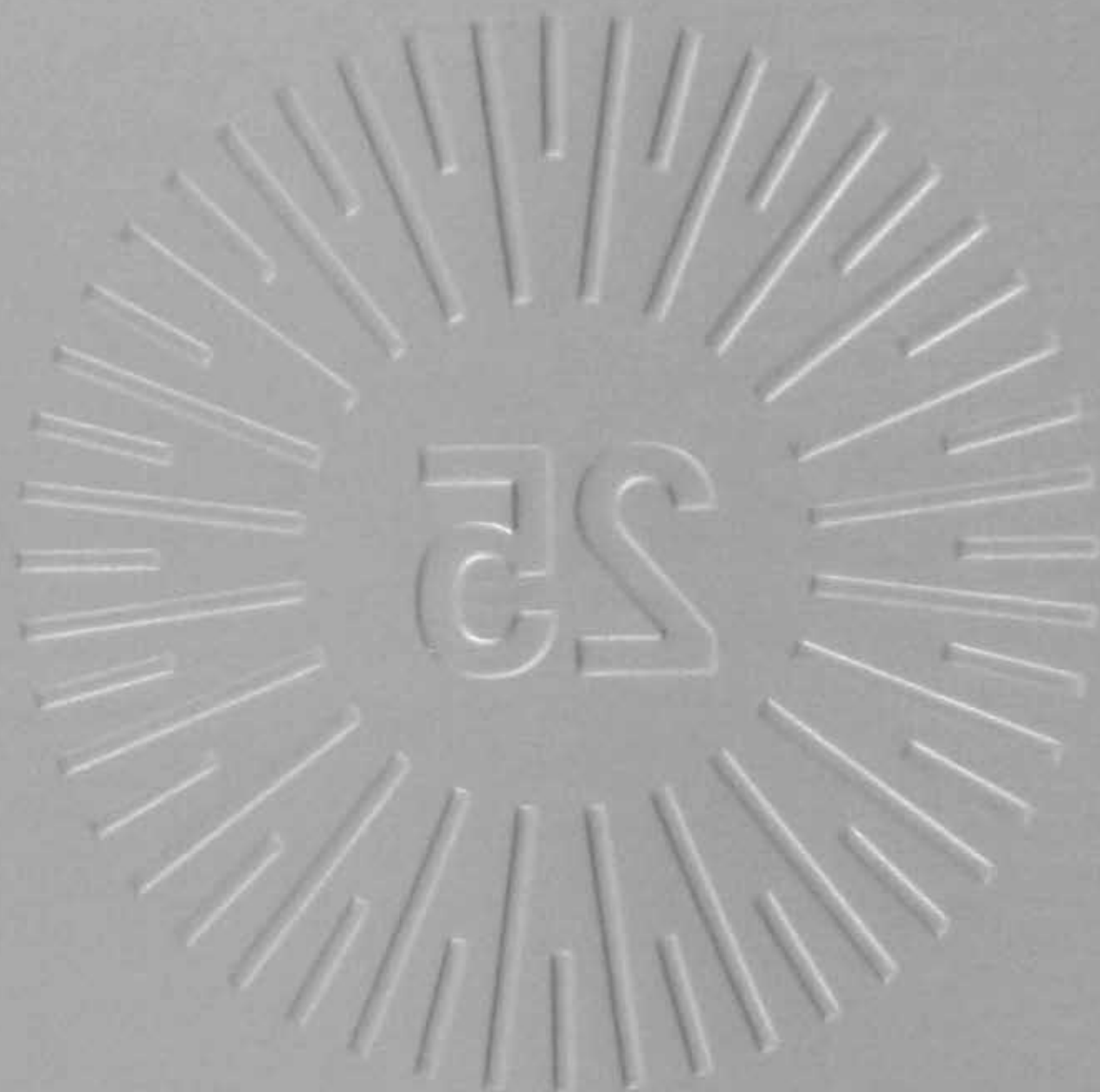

CONNECT CELEBRATES 25 YEARS OF INNOVATION







Message from Duane Roth.....	2
CEO, CONNECT	
Message from David Hale .....	3
Chairman of the Board of Directors and Co-founder, CONNECT	
Agenda.....	5
25 Years of Innovation.....	6
25th Anniversary Committee.....	24
Silver Circle Contributors.....	26
Special Guest: Marvin Hamlisch.....	28
Principal Pops Conductor, San Diego Symphony	
Lead Silver Circle Sponsor Thank You.....	33



# MESSAGE FROM DUANE ROTH

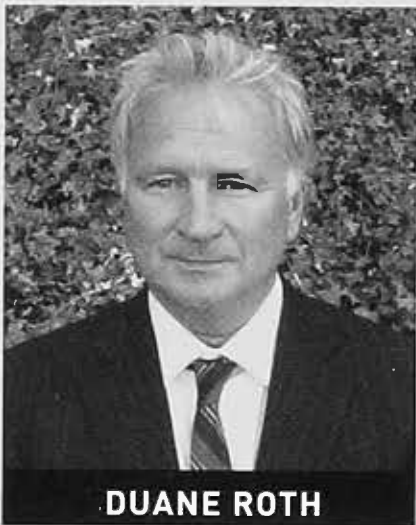

Friends of CONNECT,

On behalf of CONNECT and our board of directors, I am pleased to welcome you to a celebration of 25 years of innovation in San Diego. Today we honor our founders and all of the key individuals and organizations that have been instrumental to the growth and success of CONNECT.

Thanks to a technology community that provides 25 percent of regional wages and a median wage that rivals major centers such as New York, Chicago and San Francisco, the CONNECT program is much emulated around the world. We host weekly delegations that want to understand how we achieved this dramatic economic transformation for San Diego. Today, more than 40 regions around the world have a CONNECT-like program. In fact, just this year the New York City Council Speaker of

the City announced the city's intention to create CONNECT NYC, modeled after CONNECT San Diego. Recognizing CONNECT as one of the nation's first incubators, the May issue of *Inc.* magazine featured 20 initiatives across the nation that are transforming the raw materials of ideas into fully formed, job-generating businesses. CONNECT was the only accelerator highlighted in California. We have been honored to work with the U.S. Secretary of Commerce, Kauffman Foundation and Brookings Institute as they study CONNECT as one of the models to stimulate the economic growth of regions across the U.S.

CONNECT's success today is a result of the solid foundation from which we were built. It is based on the combined efforts of our founders Richard Atkinson, David Hale, Irwin Jacobs, Dan Pegg, Lea Rudee, Mary Walshok, Bob Weaver and Buzz Woolley; the visionary leader Bill Otterson; UC San Diego; hundreds of sponsors and members; and thousands of volunteers. Today we honor all who have helped develop, drive and grow CONNECT into what it is today - the world's most successful regional program linking inventors and entrepreneurs with the resources they need to support them on their path to commercialization.

I would like to offer a special thanks to our Lead Silver Circle sponsors Cooley LLP, COX Business, DLA Piper, Ernst & Young, KPBS, Qualcomm Inc., Silicon Valley Bank and Sughrue Mion PLLC for their support of today's Silver Anniversary celebration. Thank you also to the San Diego Symphony and Marvin Hamlisch for making a special cameo appearance in our program this evening.

I hope that you enjoy tonight's celebration and look forward to your participation over the next 25 years!

Sincerely,

Duane Roth  
CEO, CONNECT



Friends of CONNECT,

It has been my pleasure to serve as the Chairman of the Board of Directors of CONNECT for the past six years. As Chairman and one of the original co-founders of CONNECT, I would like to thank all of the individuals and organizations that have been instrumental in the success and growth of CONNECT over the years, and who continue to support our efforts as we move forward.

When a small group of us founded CONNECT in the mid '80s, the San Diego regional economy was in crisis. Traditional industries were on the decline, the attraction of companies to the San Diego region was very difficult and regional leaders were searching for a path to economic renewal and sustained growth.

Meanwhile, innovative high tech and life sciences companies such as IMED, IVAC, Linkabit, SAIC, Qualcomm and Hybritech were quietly developing in the San Diego region, fueled in part by technology and scientists at research institutions on the Torrey Pines Mesa. Community leaders recognized in this

an opportunity to transform San Diego's growing research capabilities into commercially viable products and businesses that would ultimately increase the prosperity of the region.

Twenty-five years later, the San Diego economy has been transformed into one of the leading innovation hubs in the world. The challenge of the moment is to sustain the region's ability to continuously innovate and build clusters as new scientific breakthroughs occur and new technologies become commercializable. In order to do this, CONNECT has made a series of commitments for the next 25 years, which will enhance the region's ability to continue to grow and be competitive in meeting what today is not just a national challenge but an international challenge. Sustaining an innovation economy over the next 25 years is as important as starting and developing it over the last 25. CONNECT is prepared to continue to be a driver of that sustainability. However, to do so requires new kinds of activities and new forms of support for CONNECT's work.

In honor of CONNECT's Silver Anniversary, the organization's founders and current Board of Directors are leading a campaign to create the Bill Otterson Legacy Fund. Bill Otterson was a visionary who believed that innovation focused collaboration among San Diego's research, academic, business and civic communities would not only help create new inventions, companies and jobs, but would elevate the quality of life for all San Diegans.

The Bill Otterson Legacy Fund will provide CONNECT with the flexibility to respond quickly to the extraordinary opportunities and challenges that face our region while the organization continues to provide its invaluable support of innovation and start up of high growth technology and life sciences companies.

On behalf of the board of directors of CONNECT, I thank you for your support and look forward to working with you as we continue to accelerate the growth of San Diego's innovation economy.

Sincerely,



David Hale

Chairman of the Board of Directors and Co-founder, CONNECT



Qualcomm congratulates CONNECT on  
25 years of accelerating innovation.

# INNOVATION IS IN THE AIR.

As the world leader in next-generation mobile technologies, Qualcomm is focused on creating innovative wireless solutions and ultimately accelerating mobility around the world.

[qualcomm.com](http://qualcomm.com)

**QUALCOMM**



CELEBRATING 25 YEARS OF  
WIRELESS  
INNOVATION

**ONQ** [qualcomm.com/blog](http://qualcomm.com/blog)

**facebook** [facebook.com/qualcomm](http://facebook.com/qualcomm)

**twitter** [twitter.com/qualcomm](http://twitter.com/qualcomm)



5:30 p.m.      **REGISTRATION AND NETWORKING**  
Grande Ballroom

6:30 p.m.      **WELCOME**  
Mayor Jerry Sanders

David Hale, Chairman of the Board of Directors and Co-founder, CONNECT;  
Chairman and CEO, Hale BioPharma Ventures LLC

**HISTORY OF CONNECT**  
Mary Walshok, Co-founder, CONNECT; Associate Vice Chancellor,  
Extended Studies and Public Programs, UC San Diego

**OTTERSON LEGACY FUND**  
David Hale  
Otterson Family

**PERFORMANCE BY MARVIN HAMLISCH**  
Principal Pops Conductor, San Diego Symphony

Introduction by Irwin Jacobs, Co-founder and Board Member, CONNECT;  
Co-founder and Board Member, Qualcomm Inc.

**CONNECT SILVER ANNIVERSARY VIDEO PRESENTATION**

**FOUNDERS' RECOGNITION**

7:30 p.m.      **NETWORKING**

8:00 p.m.      **EVENING CONCLUDES**

# 1985 TWENTY FIVE YEARS OF INNOVATION

CONNECT is founded by: Irwin Jacobs, Bob Weaver, Richard Atkinson, Lea Rudee, Mary Walshok, Buzz Woolley, David Hale and Dan Pegg.



Meet the Researchers and Meet the Entrepreneur programs are launched.

The San Diego Venture Group (SDVG) is founded by Ray McKewon, Ronald Meadows, Terry Schmidt, John Sherman, Michael Stolper, Sanjay Subhedar, Duwaine Townsen and Bob Weaver.



Mary Walshok hires Bill Otterson as CONNECT's first Entrepreneur-in-Residence.

Barbara Bry joins as Associate Director the following week.

## 1986



# 1988

CONNECT publishes our first membership directory.



The San Diego Technology Financial Forum is launched in partnership by CONNECT, the EDC, Gray Cary, Knobbe and Bank of America.

Under the leadership of Cub Parker, CONNECT launches the Most Innovative New Product Awards.



Founding and sustaining sponsors and companies that continue to support CONNECT today:

Arthur Young & Co.  
(now Ernst & Young)

Avalon Ventures

Bank of America

Deloitte, Haskins & Sells

Domain Associates

Enterprise Partners

Ernst & Whinney  
(now Ernst & Young)

Gen-Probe, Inc.

Gray, Cary, Ames & Frye (now DLA Piper)

Kleiner, Perkins, Caulfield & Byers

Knobbe, Martens, Olson & Bear

Latham & Watkins

Luce, Forward, Hamilton & Scripps

Price Waterhouse

Procopio, Cory, Hargreaves & Savitch

Qualcomm Inc.

San Diego Economic Development  
Corporation

Science Applications International  
Corporation

Sheppard, Mullin, Richter & Hampton



1989

Bry launches Athena.



Abigail Barrow is hired as Project Coordinator and her role evolves into Director of Programs.



The Biotechnology/  
Biomedical Corporate  
Partnership Forum is  
launched.



Carole Ekstrom joins  
as Director of Sponsor  
and Member Services.

1990

# 1991

Mentus and Guy Iannuzzi produce the CONNECT directory pro bono until 1997.

BIOCOM founded by Jim McGraw and David Hale.



# 1993



The Springboard program is launched and each month an entrepreneur receives feedback from a panel of CONNECT sponsors.



 **BIOCOM**

CONNECT launches the Defense Conversion Program with the help of the EDC, City College and the San Diego Consortium and Private Industry Council (now San Diego Workforce Partnership) to help transition displaced defense innovators into commercial industries.

Otterson starts The Bill Otterson Letter.

The San Diego Software Industry Council is founded by Nikki Krutop, Art Budman, John Neal, Paul Stannard and Jim DeLapa. Bill Otterson and Dan Pegg provided guidance instrumental to the organization's early success.



# 1992

# 1994

CONNECT is an early adopter of the Internet with the launch of CONNECTNET, an online database of investors and technology resources.

To impact FDA reform legislation, CONNECT completes a study with Price Waterhouse to explore ways to streamline the drug approval process and presents findings to the House Commerce Subcommittee on Oversight and Investigation.



To meet federal clean air requirements by the 1999 deadline without negatively impacting employers CONNECT creates the Transport Demand Management Program.

Crossborder CONNECT is launched to foster cross border regional economic development and help pass NAFTA.

The California Environmental Technology Center is launched to accelerate environmental technology development and commercialization.

Bry launches monthly CONNECT TV Show.



# 1995



# 1996

Bill Otterson wins the national E & Y Entrepreneur of the Year Award.

CFO CONNECT is launched.

The Band of Angels and Tech Coast Angels merge and CONNECT takes on program administration.



GEORGE GILDREN, BOB CONN AND IRWIN JACOBS  
AT THE FIRST EVOLVING MARKETS CONFERENCE



CONNECT InVest is founded to create a database of angel investors and source investments in local VC funds.

SDVG and CONNECT partner to hold the annual Technology Convergence Conference.

CONNECT holds the AG BIO Conference.

John Otterson conceives of Evolving Markets in Telecommunications and George Gildren is the first keynote.

CONNECT Entrepreneurs' Roundtable is launched.

# 1997

# 1998

Jim Pope pulls team together to launch San Diego Telecom Council (SDTC, now CommNexus) including Vicki Marion, Martha Dennis, Lance Bridges, John Otterson, Jim Skeen, Mike Krenn, Marco Thompson, Joe Markee, Franz Birkner, Mark Dankberg, Jeff Jacobs, Lindsey Burroughs, Bill Stensrud, Tom Dillon, Dave Overskei, David Lyon and Bill Otterson.



VICKI MARION IS 1ST CHAIR OF SDTC AND WINS MIP IN 1997



BILL AND TED WAITT

Ekstrom and Camille Sobrian publish the special Millenium 2000 Directory with major support from Gateway.

Bill passes away after a 20 year battle with cancer.



# 1999

# 2000

For the next year Abi Barrow and Carole Ekstrom shepherd CONNECT's programs with support from Extension COO, Berit Durler.

Harvard Professor Michael Porter studies San Diego for the U.S. Council on Competitiveness study on "Clusters of Innovation" and credits San Diego for dramatically outpacing the nation in job creation, productivity and exports and VC funding.



The University seeks a replacement for Bill and hires Fred Cutler. CONNECT builds more alliances with tech transfer offices on campus and across the Mesa.

A series of dinner meetings is launched – Nicholas Negroponte, co-founder and director of the MIT Media Laboratory is early speaker.

CONNECT experiments with different business, leadership and governance models.

# 2001



# 2002

Distinguished  
Contributors Award  
given to Tyler Orion  
in 2002.



TEMECULA CONNECT HEAD RON BRADLEY AND  
CAMILLE SOBRIAN



Distinguished  
Contributors  
Award given to  
Marco Thompson  
in 2003.

Global CONNECT is formed due to growing interest in other regions and countries in the CONNECT model and the formation of Cross Border CONNECT, CONNECT Sweden, Scotland, Temecula and Sacramento.

The CONNECT board decides to return to a collaborative, community-based approach.

Walshok forms a search committee to find a new director led by David Hale and comprised of Malin Burnham, Duane Roth, Marco Thompson, Abby Silverman, Martha Dennis and Paul Kreutz.

# 2003

# 2004

Distinguished Contributors Award given to Jim Berglund.

Greg Horowitz moves from CONNECT to UC San Diego Extension, to formalize Global CONNECT with Walshok.

CONNECT refocuses on its regional agenda, rebuilding membership support and its volunteer base.

**GlobalCONNECT**



# 2005

By acclamation the search committee invites Duane Roth to become the next Director of CONNECT.

Hecht-Nielsen Neurocomputer Corporation is honored with the William W. Otterson Award.

CONNECT spins out from the University to better serve San Diego's entire research community.

The Regional Technology Alliance merges with CONNECT and Tyler Orion becomes CONNECT COO.

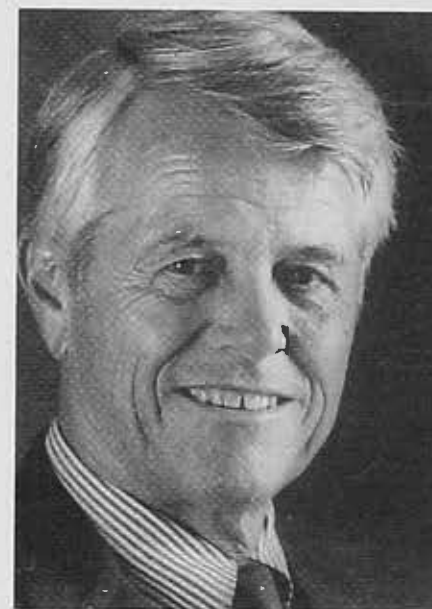

Bill Carpenter, Marco Thompson and Camille Sobrian rebuild Springboard.

Rob McCray, Don Jones and Camille Sobrian co-found the Wireless Life Sciences Alliance (WLSA) with the help of CONNECT and BIOCOM.

Malin Burnham launches the Entrepreneur Hall of Fame Awards and Irwin Jacobs is the first inductee.

Distinguished Contributors Award given to Bill Carpenter.

CONNECT takes on program administration of MIT Enterprise Forum San Diego.

Bethany Kraynack joins CONNECT Team and her role evolves into leadership of CONNECT's Education Programs.



Wireless-Life Sciences  
Alliance

**MIT** ENTERPRISE FORUM  
SAN DIEGO



When the new CONNECT board is formed, Barbara Bry, Malin Burnham, Jerry Caulder, Ray Dittamore, Cub Parker, Peter Preuss and Abby Silverman Weiss are named Honorary Lifetime Members along with CONNECT's founders.



CONNECT's Financial Forum and RTA's venture programs are revamped into Venture Roundtable.

Hall of Fame inducts Walter Zable and Ivor Royston.

Hybritech Incorporated is honored with the William W. Otterson Award.

Distinguished Contributors Award given to David Hale for Life Science; Peter Preuss for Technology.

CONNECT EIR Ruprecht von Buttlar comes on board to manage the Springboard program.

# 2007

Camille Sobrian joins CONNECT as COO.

CONNECT takes on program management of CEO Strategy Forum founded by Michael Lurie and WLSA.

Karen Winston is hired to take on program management of WLSA and MIT Enterprise Forum San Diego.

Tyler Orion launches the CONNECT Innovation Report and is named an Honorary Lifetime Member of the Board of CONNECT.



The board of CONNECT approves creation of CleanTECH San Diego at the recommendation of Roth, and he launches the organization along with Jim Waring and Tony Haymet.

Hall of Fame inducts William Rastetter.

Cymer is honored with the William W. Otterson Award.

Distinguished Contributors Award given to Ted Roth for Life Science; Mary Walshok for Technology.



# 2008



At the recommendation of the CONNECT board, Deal Network is launched.

Taylor Peterson comes on board to head CONNECT's Innovation Programs.



Reo Carr leads launch of CONNECT Homeland Security initiative with the support of Linden Blue, Ken Slaght, Jim Zortman, Rick Ludwig, Steve Koepenick, Mike Elconin, Eli Mansour, Susan Snow and Gene Ray.

Hall of Fame inducts Robert Beyster.

Pyxis MedStation is honored with the William W. Otterson Award.

Distinguished Contributors Award given to Joe Panetta for Life Science; Neil Senturia and Barbara Bry for Technology.

PYXIS



# 2009

Under the leadership of Dan Goldin, CONNECT holds the La Jolla Conference on Innovation Support for National Security to explore autonomous robotic and cyber security solutions to 21st century threats.

The board of CONNECT approves creation of San Diego Sport Innovators at the recommendation of Marco Thompson.

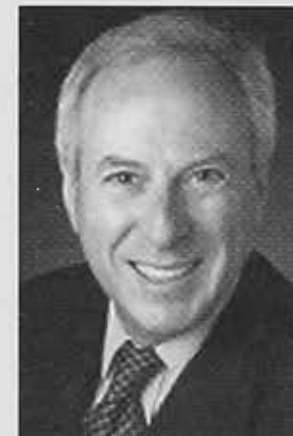

SDSI CO-CHAIRS LUDO BOINNARD AND MARCO THOMPSON



CATHERINE MACKEY



CONNECT-Assist is created to help attract and retain research talent.

La Jolla Research & Innovation Summit is launched in partnership with SDVG, CommNexus, BIOCUM, CleanTECH San Diego and SDSIC.

Technology Transfer Roundtable begins work on Seed Fund to finance provisional patents and prototyping.

Tyler Orion, Mike Krupp, former CONNECT COO June Cocheles and Greg Horowitz help create The La Jolla Conference on Accessing Federal Funding.

General Atomics is honored with the William W. Otterson Award.

Distinguished Contributors Award given to Catherine Mackey for Life Science; for Todd Gutschow for Technology.

Hall of Fame inducts Neal and Linden Blue.

# 2010

CONNECT opens DC office and hires Timothy Tardibono as DC Policy Director.

The Biogen Idec Young Innovators Program is created by CONNECT to inspire middle and high school students to pursue life sciences careers.

USD and CONNECT launch the Technology Entrepreneurship Law Clinic.



NBA Legend Bill Walton becomes Executive Chairman of CONNECT SD Sport Innovators.

The Professional Services Provider Initiative is launched with Symposium and online Resource Guide.

CONNECT/Calit2 grants portal and revamped Financial Forum are launched to increase access to capital.

SPAWAR and CONNECT partner to hold Wireless Health and EMR Conference track at AFCEA West.

Weekly eNews and Policy News are launched.

Roth co-authors Kauffman Paper on new model for drug discovery and development.

Hall of Fame inducts Peter Preuss.

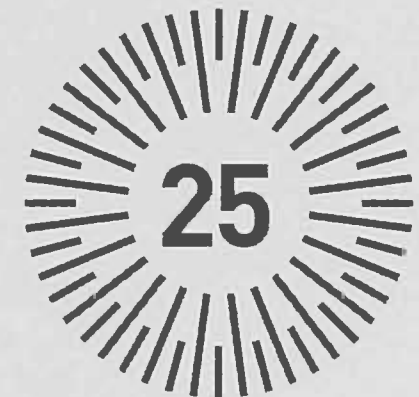

CONNECT celebrates its 25th anniversary.

# The world is banking on innovation. And so are we.

Every day Silicon Valley Bank clients push the boundaries of what was previously thought possible. Their innovations make our lives more efficient, connect people across geographies, make our environment cleaner and safer, eradicate disease and improve the quality of life. Their vision for the world will create a better future. We're banking on it.

Frederick "Buzz" Kreppel, Senior Relationship Manager Phone 858.784.3321 E-mail [bkreppel@svb.com](mailto:bkreppel@svb.com)

Andy Pelletier, Senior Relationship Manager Phone 858.784.3323 E-mail [apelletier@svb.com](mailto:apelletier@svb.com)

Mike White, Senior Relationship Manager Phone 858.784.3310 E-mail [mwhite@svb.com](mailto:mwhite@svb.com)

4370 La Jolla Village Drive, Suite 860 San Diego, California 92122

SVB> *Find a way*

Silicon Valley Bank

[svb.com](http://svb.com)





## Ready to celebrate?

There's no better reason than a milestone achievement. As a founding member, Ernst & Young is proud to congratulate CONNECT on its 25 years of support to San Diego's technology and life science businesses.

**Cheers!**  
ey.com

 **ERNST & YOUNG**  
Quality In Everything We Do



A SPECIAL THANK YOU TO CONNECT'S  
25TH ANNIVERSARY COMMITTEE

BARBARA BRY

CAROLE EKSTROM

IRWIN JACOBS

ANNE OTTERSON

CULVER "CUB" PARKER

TAYLOR PETERSON

CAMILLE SOBRIAN

MARY WALSHOK



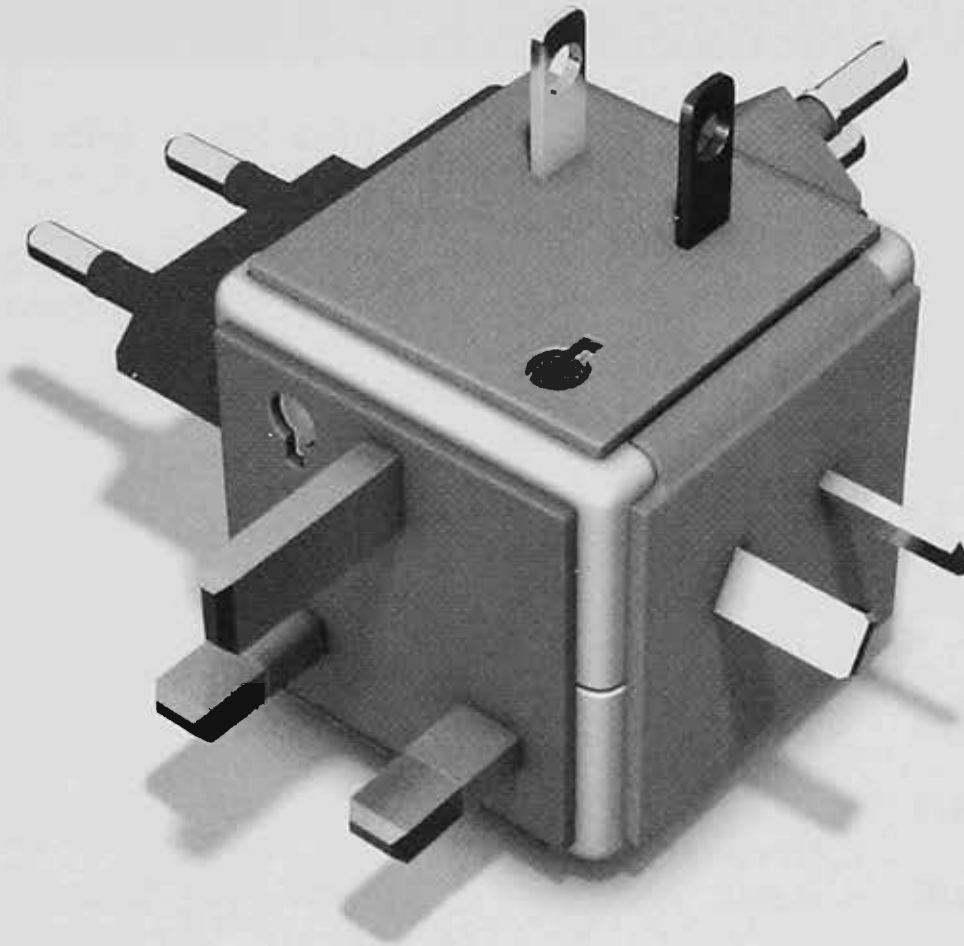

# GET CONNECTED

DLA Piper is proud to support CONNECT.  
We congratulate you on your 25th anniversary and salute  
your vision to accelerate the innovation economy in San Diego.  
When it matters to our communities, it matters to us.

[www.dlapiper.com](http://www.dlapiper.com) | DLA Piper LLP (US)

EVERYTHING MATTERS





# SILVER CIRCLE CONTRIBUTORS

**Richard Atkinson**

UC San Diego

**Roger Benham**

Radcor

**Bob and Darcy Bingham**

**Phil and Catherine Blair**

Manpower Inc.

**Julia Brown**

UC San Diego

**Barbara Bry and  
Neil Senturia**

Blackbird Ventures

**Malin and Roberta  
Burnham**

The Burnham Foundation

**Patricia Burns**

Primary Funding Corporation

**John and Lisa Butters**

Nativis, Inc.

**Bill Carley**

Pfizer

**William and Debbie  
Carpenter**

DriveCam, Inc.

**Reo Carr**

San Diego Business Journal

**James Clark**

Mexico Business Center

**William Comer**

Neurogenetic Pharmaceuticals

**Amy Corton**

Enterprise Partners Venture  
Capital

**Ruth Covell**

UC San Diego

**Angela Cummings**

The Eclipse Group, LLP

**John Dunn**

Biogen Idec

**Sanford Ehrlich**

San Diego State University

**Carl Eibl**

Enterprise Partners Venture  
Capital

**John Evey**

J. Craig Venter Institute

**Tom Gable**

Gable PR

**Dani Grady**

Cancer Survivorship: San Diego!

**Ralph Greenspan**

Neurosciences Research  
Foundation, Inc.

**David Hale**

Hale BioPharma Ventures

**Vanessa Herbert**

PricewaterhouseCoopers LLP

**Reena Horowitz**

**Irwin and Joan Jacobs**

Irwin & Joan Jacobs  
Foundation

**John Jarvis**

Irving Hughes, Inc.

**Deborah Jondall**

PricewaterhouseCoopers

**Mel and Linda Katz**

Manpower Inc.

**Jennifer Kearns**

Duane Morris LLP

**Ann Kerr**

AK Consulting

**James Kidrick**

San Diego Air and Space Museum

**Mike Kinkelaar**

Procopio, Cory, Hargreaves &  
Savitch LLP

**Rob Kramarz**

Tech Cost Angels

**Kyocera**

**Cheston Larson**

Latham & Watkins LLP

**Stephen Lobbin**

The Eclipse Group, LLP

**Rob Logan**

ICA Consulting

**Tom Lupfer**

Clarity Design, Inc.

**Catherine Mackey and  
Bill Carley**

Pfizer Inc.

**David Marino**

Irving Hughes, Inc.

**Scott McClendon**  
Overland Storage Inc

**John Miller**  
Life Technologies Corporation

**Daniel Minter**  
Duane Morris LLP

**William Molloie**  
PricewaterhouseCoopers

**Rory Moore**  
CommNexus San Diego

**Glenn and Linda Mosier**  
UBS Financial Services

**Tyler Orion**

**Anne Otterson**

**Cole and Lynn Owen**  
Owen & Associates

**Cub Parker**

**Elliot Parks**  
Hawaii Biotech

**Joanne Pastula**  
Junior Achievement of San Diego, Inc.

**Dan and Pat Pegg**

**Hiep Pham**  
Duane Morris LLP

**Ethna Piazza**  
Chamberlain Hrdlicka

**Alan Portela**  
CliniComp

**Maria Rimicci**

**Ted Roth**  
Roth Capital Partners

**Lea Rudee**  
UC San Diego

**David Saltman**  
Solesco Energy Services

**Jim and Marie-Therese  
Schaeffer**  
Merck Research Labs

**Adam Simpson**  
Latham & Watkins LLP

**Bob Slapin**  
San Diego Software Industry  
Council

**James Stacy**  
B2B Marketing Studio

**Larry and Pamela  
Stambaugh**  
CryoPort

**Deborah Szekely**  
Rancho La Puerta

**Nancy Taylor**  
San Diego Science Alliance

**Jackie Townsend-Konstanturos**  
Restorative Remedies

**James Sahagian**  
San Diego Gas & Electric

**Shekhar Vyas**  
Eclipse Group

**Mary Walshok**  
UC San Diego Extension

**Jim Waring**  
CleanTECH San Diego

**Bob Weaver**

**David Webb**  
Celgene

**Jack and Judith White**

**Caroleen Williams**  
Quasar Federal Systems

**Stephen Williams**  
SENTRY Partners

**Mitch Woodbury**

**Buzz Woolley**

**Donovan Yeates**  
KAER Biotherapeutics

# MARVIN HAMLISCH

Marvin Hamlisch's life in music is notable for its great versatility as well as substance. As composer, he has won virtually every major award that exists: three Oscars®, four Grammys®, four Emmys®, a Tony® and three Golden Globe® awards; his groundbreaking show, *A Chorus Line*, received the Pulitzer Prize.

Hamlisch is the composer of many motion picture scores including his Oscar®-winning score and song for *The Way We Were* and his adaptation of Scott Joplin's music for *The Sting*, for which he received a third Oscar®. His prolific output of scores for films include original compositions and/or musical adaptations for *Sophie's Choice*, *Ordinary People*, *The Swimmer*, *Three Men and a Baby*, *Ice Castles*, *Take the Money and Run*, *Bananas*, *Save the Tiger* and his latest effort *The Informant!*, (Sept. 2009) starring Matt Damon and directed by Steven Soderbergh.

Marvin Hamlisch holds the position of principal pops conductor for the National Symphony Orchestra, Pittsburgh Symphony Orchestra, Colorado Symphony Orchestra, Milwaukee Symphony Orchestra, Seattle Symphony and San Diego Symphony. He was musical director and arranger of Barbra Streisand's 1994 concert tour of the U.S. and England as well as of the television special, *Barbra Streisand: The Concert* (for which he received two of his Emmys®).

As a graduate of the Juilliard School of Music and Queens College (where he earned a Bachelor of Arts degree), Hamlisch believes in the power of music to bring people together. "Music can make a difference. There is a global nature to music, which has the potential to bring all people together. Music is truly an international language, and I hope to contribute by widening communication as much as I can."





A black and white photograph of Marvin Hamlisch, an older man with short, light-colored hair and glasses. He is wearing a dark turtleneck sweater and is captured in a moment of conducting. His right hand is raised, with fingers spread, and his left hand is partially visible at the bottom left, holding a baton. The background is dark and out of focus.

Marvin Hamlisch  
Principal Pops Conductor,  
San Diego Symphony

*Mr. Hamlisch is making a special cameo appearance in honor of CONNECT's 25th Anniversary and the 100th Anniversary of the San Diego Symphony.*

*CONNECT would like to thank Marvin Hamlisch for tonight's performance.*

PATENTS

TRADEMARKS

COPYRIGHTS

LITIGATION

PROSECUTION

LICENSING

COUNSELING

Protecting the  
most important ideas  
in the universe.

**YOURS.**

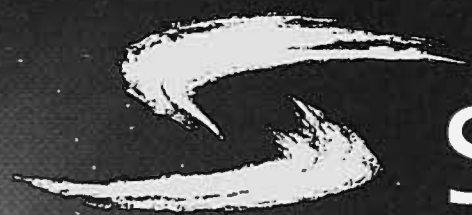

**Sughrue**

SUGHRUE MION, PLLC

Washington, DC  
202.293.7060

Silicon Valley  
650.625.8100

San Diego  
619.238.3545

Tokyo  
011.81.3.5220.0200







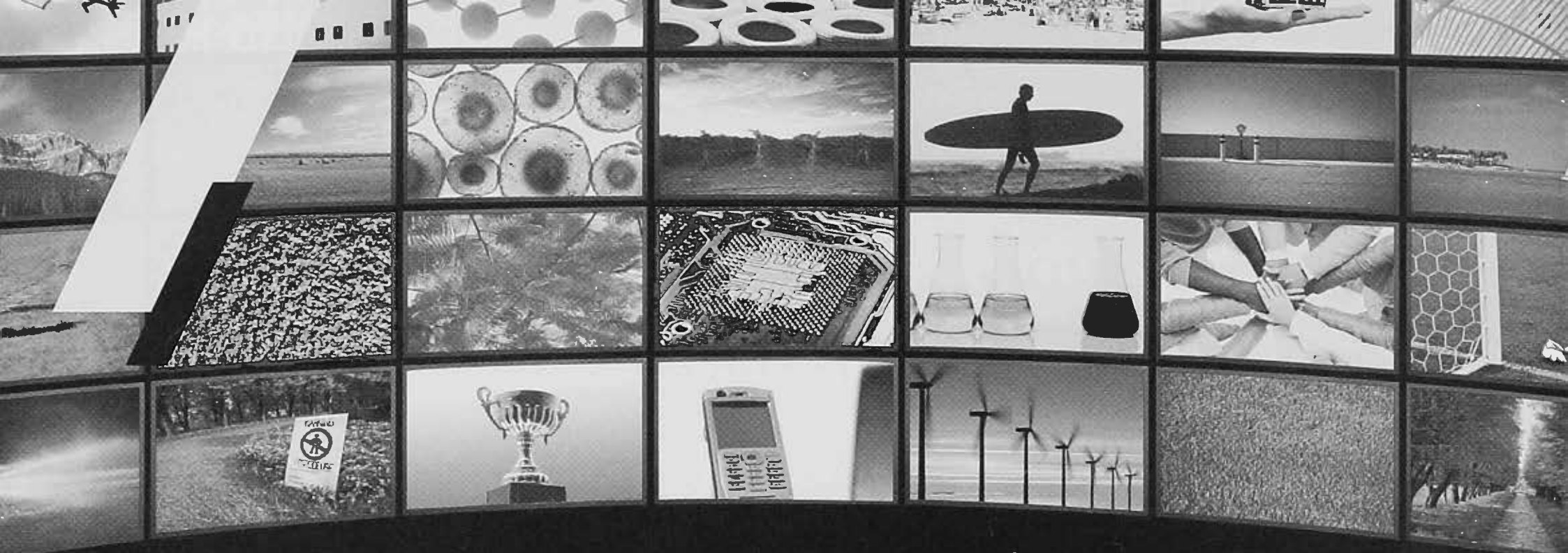

**Cooley is proud to be a long-time supporter of CONNECT  
and is pleased to honor the CONNECT founders and leaders  
who have helped shape the San Diego business community.**

---

Cooley, a national law firm for the converging worlds of  
high technology, high finance and high-stakes litigation.  
For more information, visit us at [www.cooley.com](http://www.cooley.com)

**Cooley**  
LLP

---

Cooley LLP, 4401 Eastgate Mall, San Diego, CA 92121. 858/550-6000.

Cooley  
LLP

cox  
Business®

 DLA PIPER

 ERNST & YOUNG

KPBS | 50 YEARS 

QUALCOMM®

SVB  Silicon Valley Bank  
A Member of SVB Financial Group

 Sughrue  
SUGHRUE MION, PLLC



# KPBS Celebrates the Sixties!

In Honor of our 50th Anniversary

**Saturday, October 9**

**The Lodge at Torrey Pines**

Great people. Good food. **Groovy music.**

**Don't miss this party!**



Happy together for 50 years.

For sponsorship and ticket information

**[kpbs.org/50years](http://kpbs.org/50years)**







