

SANTA FE IRRIGATION DISTRICT

From the papers of Ed Fletcher, the following letters were removed to the alphabetized correspondence files

BAKEWELL, Robert (Sec'y-Mgr, Santa Fe Irr. Dist.)

Bakewell to Fletcher, 10/22/46

Fletcher to Bakewell, 10/23/46

BECHBERGER, Wm. A. (Tax Collector)

Fletcher to Bechberger, [4 letters] 5/31/29, 6/19/29, 6/26/29, 10/29/29

Bechberger to Fletcher, [3 letters] 11/20/29, 12/19/29, 12/23/29

BOETTIGER, W.O. (Mgr)

Fletcher to Boettiger, [8 letters] 1/7/29, 1/26/29, 2/1/29, 5/7/29, 5/27/29, 9/25/29, 9/25/29, 10/5/29

Boettiger to Fletcher, [3 letters] 1/24/29, 5/29/29, 10/2/29

Boettiger "To All Water Consumers," 5/4/29

CALIFORNIA CORRUGATED CULBERT CO. to King, 6/30/19

MYERS, Maurice, entire correspondence file of MYERS, MAURICE, Aug-Nov. 1944

TAIT, C. E.

Tait to King, [2 letters] 5/24/19, 7/3/19

King to Tait, [2 letters] 6/26/19, 7/17/19

Tait to Fletcher, 5/27/19

OPTION TO PURCHASE TAX-DEEDED LANDS

THIS AGREEMENT, made and entered into this ____ day of _____, 19__, under and by virtue of the provisions of Division 1, Part 6, Chapter 8, Articles 1, 2, and 3, of the Revenue and Taxation Code of the State of California, as amended, by and between:

THE BOARD OF SUPERVISORS OF THE COUNTY OF SAN DIEGO, STATE OF CALIFORNIA,

Party of the First Part,

and

THE SANTA FE IRRIGATION DISTRICT

_____ a
of the State of California

Party of the Second Part,

WITNESSETH:

WHEREAS, certain lands hereinafter described, situated in the County of San Diego, State of California, and also within the boundaries of SANTA FE IRRIGATION DISTRICT

_____, have been tax-deeded to the State of California for delinquent County taxes and/or assessments; and

WHEREAS, the same lands have also been tax-sold for two or more years, or have been tax-deeded to the SANTA FE IRRIGATION DISTRICT _____ for delinquent IRRIGATION DISTRICT taxes and/or assessments; and

WHEREAS, the Board of Supervisors of the County of San Diego and the BOARD OF DIRECTORS OF SANTA FE IRRIGATION DISTRICT _____ believe that it is for the best interests, both of the County of San Diego and of the SANTA FE

IRRIGATION DISTRICT _____, that said property be sold into private ownership, to the end that said lands be restored to the assessment rolls of the parties hereto; and

WHEREAS, said lands are particularly described as follows:

COPY

Property Description

(As appears upon the County assessment roll, together with Certificate No. and date of sale to the State, and Deed No. and date of deed to the State)

Item #1. In Block 24 of Solana Beach, "Assessor's Map #38, Lot 1 and Lot B-2. Certificate #145282, Sold to State 6/29/32, Deeded to State 7/1/37, Deed #13516.

Note: When deeded to State, the above tract was included in parcel described as follows: Beginning at a pt. on Sly li of Plaza St. S 78° 31' 30" W 273.56 ft. from intersection of Sly li of Plaza St. and Wly li of Sierra Ave; th S 11° 28' 30" E 320 ft; th S 78° 31' 30" W 123.22 ft; th N 22° 26' W 125.28 ft; th N 1° 45' W 230 ft. to intersection of center li of Plaza St. produced Wly; th N 78° 31' 30" E 50 ft; th S 11° 28' 30" E 35 ft; th N 78° 31' 30" E 58.22 ft. to beg. (Ex Co. of San Diego) Now Assessor's Map #38, Lot #1.

Item #2. N 3/4 of E 1/2 of NE 1/4 of NE 1/4 of Sec. 1. T. 14 S.R. 4 W. S.B.M. Certificate #145563-D sold to State 6/29/32, Deeded to State 7/1/37, Deed #13566.

Note: When deeded to State above parcel was included in parcel described as follows: NE 1/4 (Inc. Lots 1 & 2) and NW 1/4 of SW 1/4 (Ex M & B to San Diego Mutual Water Co.) Sec. 1 T. 14 - 4 W.

Item #3. All lying Ely of A.T. & S.F. Rwy R/W in Lot 3 (Ex State Bd. of Equal. Par. 2 Map 804-37-12) & (Ex Beg. at NE cor. of Lot 28, Blk 13 Solana Beach; th N 21° 33' 30" W 826.17 ft; th N 68° 26' 30" E 40 ft; th S 21° 33' 30" E 824.42 ft.; th S 89° 40' 30" W 43.11 ft. to P.O.B. in Sec. 34-13-4W. Certificate #145413-W. Sold to State 6/29/32, Deeded to State 7/1/37, Deed #13543.

Item #4. All lying Ely A.T. & S.F. Rwy R/W in SE 1/4 of NE 1/4 in Sec. 34-13-4W. Certificate #145413-H. Sold to State 6/29/32. Deeded to State 7/1/37. Deed #13543.

Note: The above 2 parcels when deeded to State were included in a parcel described as follows: N 1/2 (Inc. Lots 1 and 2) (Ex Ry R of W) and (Ex Lot 2) and Lot 3 (NE 1/4 of SE 1/4) (Ex Ry. R of W) (Ex Map 2143) (Ex 2 M & B, Rho Santa Fe Corp) in Sec 34-13-4W"

Item #5. Sec. 35-13-4W SW 1/4 of NW 1/4 - Certificate #145417-A, Sold to State 6/29/32. Deed #13545, Deeded to State 7/1/37.

Item #6. Sec. 35-13-4W. NW 1/4 of SW 1/4 (Ex R.R.R. R/W). Certificate #145417-C. Sold to State 6/29/32. Deeded to State 7/1/37. Deed #13545.

Note: The above 2 parcels when deeded to State were included in a parcel described as follows: "SW 1/4 of NE 1/4 and SE 1/4 of NW 1/4 and NW 1/4 of NW 1/4 and N 1/2 of SW 1/4 (Ex 2 M & B Rho Santa Fe Corp) and SE 1/4 in Sec 35-13-4W"

NOW, THEREFORE, pursuant to authority granted by Division 1, Part 6, Chapter 8, Articles 1, 2, and 3, of the Revenue and Taxation Code of the State of California, as amended, said Board of Supervisors hereby gives and grants unto said SANTA FE IRRIGATION DISTRICT an option to purchase the above described lands upon the following terms and conditions, to wit:

1. That said DISTRICT shall have the right to exercise this option at any time within three years from the date hereof.
2. That this option is given to said DISTRICT upon the express condition that, at the time said DISTRICT exercises the same, it shall have a bona fide purchaser for said property ready, willing and able to purchase the same, and said DISTRICT shall, immediately following the exercise of this option, cause the said property to be resold and the title vested as of record in a third party, to the end that said land shall be reestablished on the assessment rolls of the County of San Diego, State of California.
3. That this option is given in consideration of the payment by said DISTRICT to the County of San Diego, by and through the Tax Collector of said County, of the following sums and at the times hereinafter set forth:

Property Description	Down Payment (As of date of Execution of Agreement)	2nd Payment (Anniversary Date of Agreement)	3rd Payment (2nd Anniver- sary Date of Agreement)	Final Payment (Upon exercise of option)
----------------------	--	--	--	---

Item #1. In Block 24 of Solana Beach, Assessor's Map #38, Lot 1 and Lot B-2.	\$15.55	\$15.55	\$15.55	\$128.04
Item #2. N 3/4 of E 1/2 of NE 1/4 of NE 1/4 of Sec. 1. T. 14 S. R. 4 W. S. B. M.	\$29.16	\$29.16	\$29.16	\$208.02
Item #3. All lying Ely of A.T. & S.F. Rwy R/W in Lot 3 (Ex State Bd. of Equal. Par. 2 Map 804-37-12) & (Ex Reg. at NE cor. of Lot 28, Blk 13 Solana Beach; th N 21° 35' 30" W 826.17 ft; th N 68° 26' 30" E 40 ft; th S 21° 33' 30" E 824.42 ft.; th S 89° 40' 30" W 43.11 ft to P.O.B. in Sec 34-13-4W.	\$31.42	\$31.42	\$31.42	\$140.45
Item #4. All lying Ely A.T. & S.F. Rwy R/W in SE 1/4 of NE 1/4 in Sec. 34-13-4W.	\$92.66	\$92.66	\$92.66	\$375.45
Item #5. Sec. 35-13-4W SW 1/4 of NW 1/4.	\$240.40	\$240.40	\$240.40	\$1516.52
Item #6. Sec. 35-13-4W NW 1/4 of SW 1/4 (Ex R.R. R/W.)	\$457.81	\$457.81	\$457.81	\$1458.39

PROVIDED, HOWEVER, that if said option is exercised prior to the due date of either the second or third payment above specified, such second or third payment, or both as the case may be, shall be canceled, and shall not in that event be due or owing to said County.

4. That said DISTRICT shall have the right to exercise this option at any time during the term hereof as to any portion of said property which, as of the date of this agreement, has a separate valuation on the assessment roll of said County; provided, further that said DISTRICT shall also have the right to exercise this option at any time during the term hereof as to any portion of a single lot, parcel or tract of said property, which lot, parcel or tract as of the date of this agreement, has a separate valuation on the assessment roll of said County. Upon exercise of said option as to any portion of such separately valued lot, parcel or tract the final payment therefor shall be a sum which bears the same ratio to the final payment set forth in Paragraph 3 herein for the entire lot, parcel or tract from which said segregated portion is taken, as the assessed valuation of said segregated portion, placed thereon by the assessor at the time of segregation, bears to the assessed valuation of said entire lot, parcel or tract as of the date of this agreement. Any such segregation shall be made pursuant to Sections 4151 to 4155 inclusive, Revenue and Taxation Code, except that the sum of the valuations of the segregated portion and the remainder of the said lot, parcel or tract, may be greater but not less than the valuation, as of the date of this agreement, of the entire lot, parcel or tract.

5. That the price for which said County hereby agrees to sell its tax title to said property to said DISTRICT shall be the aggregate amount of all payments made by said DISTRICT pursuant to Paragraph 3 hereof.

6. That this option is given SANTA FE IRRIGATION DISTRICT under the terms and conditions of Division 1, Part 6, Chapter 8, Articles 1, 2, and 3, of the Revenue and Taxation Code of the State of California, as amended, and is intended to be and shall be construed as a statutory agreement designed to carry into effect said provisions of said Code and shall have no effect or force otherwise.

IN WITNESS WHEREOF, the Board of Supervisors of the County of San Diego, by resolution duly passed and adopted on the _____ day of _____, 19____, has caused this agreement to be executed in quadruplicate, and the Santa Fe Irrigation District, by resolution duly passed and adopted on the 14th day of August, 1944, has caused this agreement to be executed in quadruplicate, by its officers thereunto duly authorized as of the day and year in this agreement first above written.

BOARD OF SUPERVISORS OF THE COUNTY OF SAN DIEGO, STATE OF CALIFORNIA

By _____
Chairman

ATTEST:

J. B. McLees, County Clerk and ex officio Clerk of the Board of Supervisors
By _____
Deputy

(SEAL)

THE SANTA FE IRRIGATION DISTRICT

By _____
President

ATTEST:

Secretary

The undersigned, Sam A. Claggett, Tax Collector of the County of San Diego, State of California, pursuant to Chapter 362, Statutes of 1943, and Chapter 409, Statutes of 1943 (Sec. 3794.2 R. & T. Code), having duly considered the above and foregoing agreement, and compared the same with the records of the County relating to the real property described therein, and being fully advised in the premises, hereby approves said agreement.

Dated _____, 19____.

Tax Collector of the County of San Diego, State of California

The undersigned, Harry B. Riley, Controller of the State of California, having duly considered the above and foregoing agreement and being fully advised in the premises, hereby approves said agreement.

Dated _____, 19____.

HARRY B. RILEY, Controller of the State of California

By _____
Deputy

Approved as to form

Date _____

THOMAS WHELAN, District Attorney in and for the County of San Diego, State of California

By _____
Deputy

6

UNIVERSITY OF CALIFORNIA PUBLICATIONS

COLLEGE OF AGRICULTURE
AGRICULTURAL EXPERIMENT STATION
BERKELEY, CALIFORNIA

**SOME MEASURING DEVICES USED
IN THE DELIVERY OF
IRRIGATION WATER**

BY

**CALIFORNIA AGENTS OF IRRIGATION INVESTIGATIONS, OFFICE OF
EXPERIMENT STATIONS, U. S. DEPARTMENT
OF AGRICULTURE**

(Based on work done under co-operative agreement between the Office of Experiment Stations and the State Engineering Department of California and between the Office of Experiment Stations and the University of California Agricultural Experiment Station.)

BULLETIN No. 247
Berkeley, Cal., January, 1915

**UNIVERSITY OF CALIFORNIA PRESS
BERKELEY
1915**

BENJAMIN IDE WHEELER, President of the University.

EXPERIMENT STATION STAFF

HEADS OF DIVISIONS

THOMAS FORSYTH HUNT, Director.
EUGENE W. HILGARD, Agricultural Chemistry (Emeritus).
EDWARD J. WICKSON, Horticulture.
HERBERT J. WEBBER, Director Citrus Experiment Station; Plant Breeding.
HUBERT E. VAN NORMAN, Vice-Director; Dairy Management.
WILLIAM A. SETCHELL, Botany.
MEYER E. JAFFA, Nutrition.
ROBERT H. LOUGHRIDGE, Soil Chemistry and Physics (Emeritus).
CHARLES W. WOODWORTH, Entomology.
RALPH E. SMITH, Plant Pathology.
J. ELIOT COIT, Citriculture.
JOHN W. GILMORE, Agronomy.
CHARLES F. SHAW, Soil Technology.
JOHN W. GREGG, Landscape Gardening and Floriculture.
FREDERIC T. BIOLETTI, Viticulture and Enology.
WARREN T. CLARKE, Agricultural Extension.
JOHN S. BURD, Agricultural Chemistry.
CHARLES B. LIPMAN, Soil Chemistry and Bacteriology.
CLARENCE M. HARRIS, Veterinary Science and Bacteriology.
ERNEST B. BABCOCK, Genetics.
GORDON H. TRUE, Animal Husbandry.
JAMES T. BARRETT, Plant Pathology.
ARNOLD V. STUBENRAUCH, Pomology.
WALTER MULFORD, Forestry.
WILLIAM G. HUMMEL, Agricultural Education.
FRANK ADAMS, Irrigation Practice.
DAVID N. MORGAN, Assistant to the Director.
Mrs. D. L. BUNNELL, Librarian.

IRRIGATION PRACTICE

(In co-operation with Office of Experiment Stations, U. S. Department of Agriculture, and
State Engineering Department of California)

FRANK ADAMS.

S. H. BECKETT.

O. W. ISRAELSEN.

SAMUEL FORTIER, Chief of Irrigation Investigations, Office of Experiment Stations.
W. F. McCLURE, State Engineer of California.

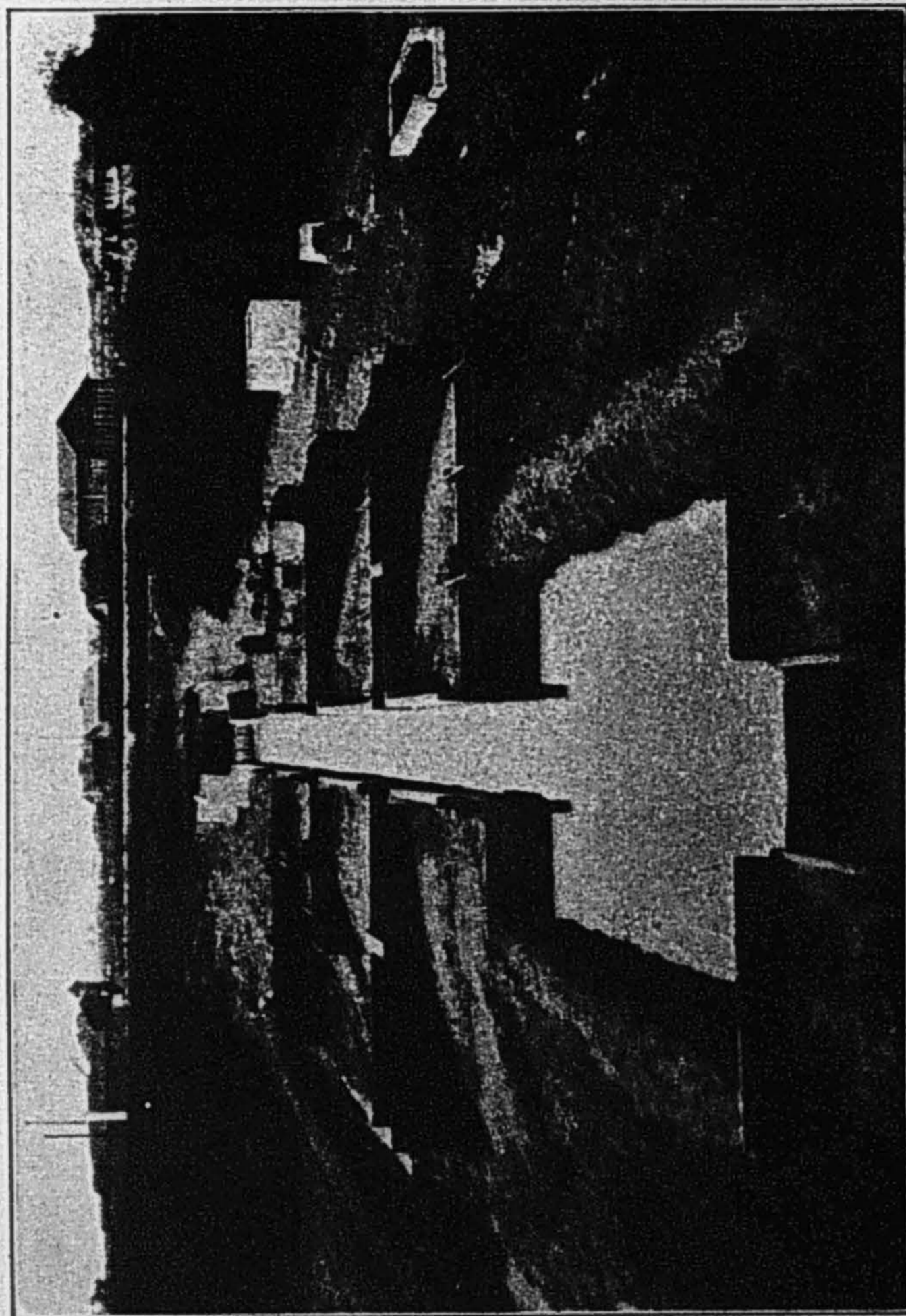

DAVIS FIELD LABORATORY OF IRRIGATION MEASURING DEVICES

CONTENTS

	PAGE
Introduction	113
Units of Water Measurement	116
The Davis Field Laboratory	117
Measuring Devices for Underground Distribution Systems	119
Azusa Hydrant	119
Gage Hydrant	121
Riverside Box	123
Foote Inch Box	124
Weirs	126
Cipolletti Weir	128
Weir Without End Contractions	139
Submerged Orifices	146
Submerged Orifices with Fixed Dimensions	147
Submerged Orifice Headgates	153
Mechanical Devices that Measure and Register the Total Flow	156
Dethridge Meter	156
Grant-Michell Meter	160
Hill Meter	161
Hanna Meter	163
Water Registers	164
Current Meters	165
Appendix—Data and Discussion of Tests of Measuring Devices	166

TABLES

Table 1. Discharge of Cipolletti Weirs, 12 to 24 inches long	131
Table 2. Discharge of Cipolletti Weirs, 3 to 5 feet long	135
Table 3. Discharge of Weirs Without End Contractions per foot of length ..	140
Table 4. Discharge of Submerged Rectangular Orifices	150
Table 5. Coefficients to be Applied to Discharges Given in Table 4 when Orifice Suppressed	152

ILLUSTRATIONS

	PAGE
Plate 1. Davis Field Laboratory of Irrigation Measuring Devices ..FRONTISPIECE	
Figure 1. Reinforced Concrete Reservoir, Davis Field Laboratory	117
Figure 2. Concrete Standardizing Box, Davis Field Laboratory	118
Figure 3. Drawing of Azusa Hydrant	120
Figure 4. Photograph of Azusa Hydrant from Above	121
Figure 5. Drawing of Gage Hydrant	122
Figure 6. Photograph of Gage Hydrant	122
Figure 7. Drawing of Riverside Measuring Box	123
Figure 8. Photograph of Riverside Measuring Box	123
Figure 9. Drawing of Foote Inch Box	125
Figure 10. Photograph of Foote Inch Box	126
Figure 11. Measuring Water with a Small Wooden Cipolletti Weir	127
Figure 12. Drawing of Cipolletti Weir and Weir Box	128
Figure 13. Photographs of Cipolletti Weir and Hanna Meter	129
Figure 14. Photograph of Weir Without End Contractions	140
Figure 15. Drawing of Submerged Orifice Used by U. S. Reclamation Service	147
Figure 16. Photograph of Submerged Orifice Used by U. S. Reclamation Service	148
Figure 17. Drawing of Submerged Orifice Headgate	153
Figure 18. Photograph of Submerged Orifice Headgate	154
Figure 19. Drawing of Dethridge Meter	157
Figure 20. Photograph of Dethridge Meter	158
Figure 21. Plan and Elevation of Installation of Grant-Michell Meter	160
Figure 22. Photograph of Installation of Grant-Michell Meter	161
Figure 23. Sectional Elevation of Installation of 12-inch Hill Meter	162
Figure 24. Photograph of Installation of 12-inch Hill Meter	162
Figure 25. Photograph of Hanna Meter	163
Figure 26. Photograph of a Water Register	164
Figure 27. Photograph of Current Meter and Equipment	165

SOME MEASURING DEVICES USED IN THE DELIVERY OF IRRIGATION WATER

BY*

CALIFORNIA AGENTS OF IRRIGATION INVESTIGATIONS, OFFICE OF
EXPERIMENT STATIONS, U. S. DEPARTMENT
OF AGRICULTURE

INTRODUCTION

The public and private advantages attending the measurement of individual deliveries of irrigation water have for many years been appreciated in the older irrigated countries and in some portions of the western United States where irrigation water has had a high sale value. Now the rapidly increasing utilization of the available water supplies and the better understanding of the principles underlying the wise making of rates to be charged for irrigation water are causing these advantages to be better understood in every irrigated section of the West. Citing only California as an illustration of this, it needs only to be said that while, outside of the southern citrus sections, appliances for measuring water deliveries were seldom considered in the design of irrigation systems ten or fifteen years ago, today no competent California irrigation engineer laying out an irrigation project would fail to give due consideration to necessary means for

* The installation of the measuring devices described in this bulletin has been carried out chiefly by S. H. Beckett and R. D. Robertson, irrigation engineers, assisted by Roy Wray. The tests of the devices have been made under the immediate direction of S. T. Harding, irrigation engineer, in charge of irrigation investigations in Montana, temporarily on duty in California, who has also prepared the reports of the tests printed in the appendix. The weir tables included have been prepared by Wells A. Hutchins. The drawings and diagrams have been prepared by Stephen O. Whipple, scientific assistant. Mr. F. L. Bixby, irrigation engineer, in charge of irrigation investigations in New Mexico, temporarily on duty in California, assisted in designing the general plan of installation. The full study has been planned and, in general, supervised, and the data have been arranged for publication by Frank Adams, Irrigation Manager.

The installation of the Davis field laboratory and the testing of the devices have been jointly paid for from funds contributed by the State Engineering Department of California, the Office of Experiment Stations of the United States Department of Agriculture, and the California Agricultural Experiment Station. Co-operation with the State Engineering Department of California has been effected through agreement between that Department and the Office of Experiment Stations, the irrigation investigations at Davis having formerly been carried on by those two agencies without financial aid from the California Agricultural Experiment Station.

measuring the water supplied to irrigators. Furthermore, the recent giving to one central public authority the power to fix rates charged for irrigation water by California public utilities has made a more general understanding of practicable means of measuring irrigation deliveries at least exceedingly desirable.

The measurement of irrigation water, while theoretically simple, is rendered quite perplexing in practice because of the varying conditions almost any irrigation measuring device is required to meet. While extreme accuracy is not expected and thus far is almost never reached, measurements within, say, from two to five per cent of correct are reasonable to expect, and no device can be considered very satisfactory that does not accomplish such a result. Sometimes, and especially in the flatter valleys, irrigation ditches are but very little higher than the land to be watered, making measurement over a weir or other device requiring a free over-fall of the water impossible. In such cases some form of the submerged orifice (p. 146) or some kind of mechanical registering meter (pp. 156-164) must be used. With almost any one of these, silt or debris carried in the water, as well as temporary changes in the canal or ditch above or below the measuring point (as from checking up the water to get it on to the higher land) sufficiently change conditions to alter results and to impair the accuracy of measurements if they are not taken account of. An additional element of difficulty is found in the fluctuations in flow that almost invariably occur on every system, the same device sometimes being required to measure less and sometimes more than the quantity it is best suited to take account of.

Besides measuring water with reasonable accuracy, under sometimes widely varying conditions, a satisfactory device for taking account of farm water deliveries must be extremely simple in design, and be made of materials that are available and inexpensive. It should at least in part be susceptible of construction by the farmer to be served, and to be widely used, should not cost above, say, from twenty-five to fifty dollars. Where all of the farmers under one lateral receive the same flow of water in rotation, each retaining it for a length of time proportional to his interest in the system or the number of acres he irrigates, a device that both measures the rate of the flow and holds that flow constant is the ideal to be sought for. While there are few devices in use that hold the flow of water constant, reasonably satisfactory results are obtained under the rotation plan by measuring or gauging the turnout with sufficient frequency to enable its being held about uniform. Where rotation on laterals is not feasible, or where independent individual deliveries are preferred,

the measuring device, to be fully satisfactory, should register the total amount of water passing rather than the rate of the flow. While this result can be accomplished by using a water register (Fig. 26) in conjunction with a weir or other device that takes account of the rate of flow, water registers require too much care and are too expensive for use in making deliveries of water to farms. The Dethridge, Grant-Michell, Hill, and Hanna meters described in this bulletin are all of the type that register the total flow rather than measure the rate of flow, and to the extent that they can be made to meet the conditions already named, are preferable to the more simple weir or orifice taken singly.

In planning and carrying out the installation at Davis three main purposes have been held in view: To assemble in one accessible place, and largely for demonstration uses, examples of the principal irrigation measuring devices so far developed; to make such tests of these devices as would demonstrate their accuracy under ordinary field conditions when compared to a standard weir and to each other; and incidentally to furnish an opportunity to students at the University Farm to make practical working tests in agricultural hydraulics. In installing the various devices the effort has been made to follow practical field rather than ideal laboratory conditions; also, in describing the devices and the tests made of them, technical language has been wholly eliminated. For the benefit of engineers, however, the full data of the various tests made are grouped together in the appendix.

There have been numerous bulletins dealing with different phases of the measurement of irrigation water issued by the Agricultural Experiment Stations of some of the western states. This bulletin is not designed to restate what these Stations have already stated, nor to deal with matters of water measurement that are of chief interest to hydraulic engineers. The purpose is rather to describe fully, illustrate by drawings and photographs, and point out the relative accuracy of some types of the devices that have already become standard or that have been in use for a sufficiently long time or on a sufficient scale to make them of enough public interest to warrant their installation at the Davis field laboratory. This field laboratory offers opportunity for the installation and testing of other irrigation measuring devices, and since this bulletin was prepared the designers of two devices have made installations there for such impartial testing as it is desired to subject them to. It is hoped to add to the demonstration from time to time, so that ultimately an example of any irrigation measuring device of merit may be seen installed under practical field conditions on the University Farm.

UNITS OF WATER MEASUREMENT

The Inch.—This is a variable unit having different meanings in different states and even in different sections of the same state. The old miner's inch of California was the quantity of water flowing freely through an opening 1 inch square, the center of which was 4 inches below the surface of the water standing above the opening, and which is equivalent to a flow of 9 gallons per minute or $\frac{1}{60}$ cubic foot per second. The present statute inch of California is defined as a flow of one and one-half cubic feet per minute. It is measured under a 6-inch pressure and is equivalent to a flow of $11\frac{1}{4}$ gallons per minute or $\frac{1}{40}$ cubic foot per second. While the meaning of the inch varies with local practise, it is *not* a stream of water 1 inch deep and 1 inch wide, regardless of pressure. Where its meaning is clear the inch is a convenient unit for measuring small streams up to, say, 50 to 100 inches, and is quite commonly used for such streams, particularly on many of the southern California systems. For larger streams its use is generally discarded in favor of the more definite cubic foot per second.

The 24-Hour Inch.—This is a very common unit, especially in southern California, and is, as its name implies, 1 inch (the exact amount of which varies with locality and local custom) running for 24 hours. Variations of this unit found on some California irrigation systems are the 1-hour inch and the 12-hour inch.

The Cubic Foot per Second.—This unit represents an exact and definite quantity of water, viz: the equivalent of a stream 1 foot wide and 1 foot deep flowing at the rate of 1 foot per second. It is therefore the most satisfactory unit for streams of one or more cubic feet per second.

The 24-Hour Second Foot.—This is one cubic foot per second, running continuously throughout a 24-hour period. It is equivalent to approximately 2 (exactly 1.9834) acre-feet.

The Acre-Foot.—This is the equivalent of a body of water 1 acre in area and 1 foot deep, or 43,560 cubic feet. As already stated, one cubic foot per second, or 50 southern California inches, or 40 California statute inches, running continuously for 24 hours will supply approximately 2 (exactly 1.9834) acre-feet.

The Acre-Inch.—This is one-twelfth of 1 acre-foot, or the equivalent of a sheet of water 1 acre in area and 1 inch deep. It is the unit sometimes used instead of the acre-foot, especially in expressing quantities of less than 1 acre-foot.

The Gallon.—As many irrigators receive their water supply from pumps and as pump manufacturers usually estimate discharges in gallons per minute or gallons per second, this is sometimes a convenient unit to use. One cubic foot is approximately equal to $7\frac{1}{2}$ gallons (exactly 7.4805) and 1 cubic foot per second is approximately equivalent to 450 gallons per minute or $7\frac{1}{2}$ gallons per second.

One Thousand Gallons.—This unit is quite common in irrigation practise in San Diego County, Calif., where the cost of irrigation water is perhaps higher than anywhere else in the United States.

THE DAVIS FIELD LABORATORY

In addition to the various measuring devices subsequently described, the Davis laboratory consists of the following elements:

(1) Reinforced concrete lined reservoir (Fig. 1) 96 feet long, 16.5 feet wide, and 5.5 feet deep, with side-slopes of 1 to 1, and with elevation of 94.8 feet above datum. This reservoir has a capacity of 11,910 cubic feet and it has been carefully calibrated. Outlet from this reservoir into the standardizing box and through it to the measuring devices is through a 15-inch vitrified clay pipe and is controlled by means of a 15-inch Western steel headgate. The reservoir is filled from a near-by well by means of a 4-inch centrifugal pump.

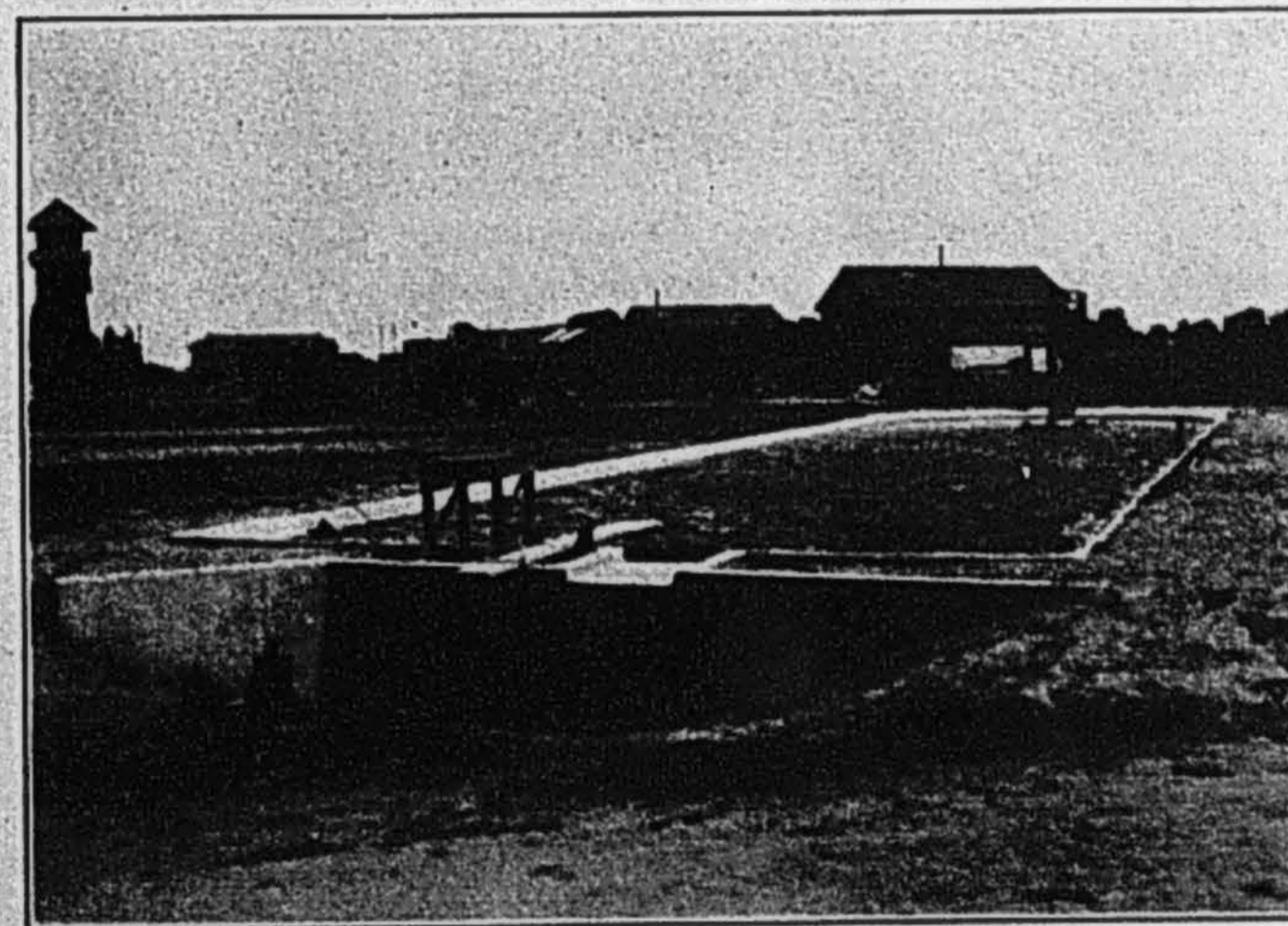

Fig. 1.—Reinforced concrete reservoir, Davis Field Laboratory

(2) Concrete standardizing box (Fig. 2), 30 feet long, 9 feet wide, and 6 feet deep (all inside measurements) with partition 12.75 feet from the upper end containing an opening 5 feet wide, 1 foot above the bottom of the box, a similar opening 5 feet wide having been left in the lower end of the box. These openings are so equipped that weirs or orifices of desired sizes can be set in them, making it possible to use either a standard weir or a standard orifice in testing the various

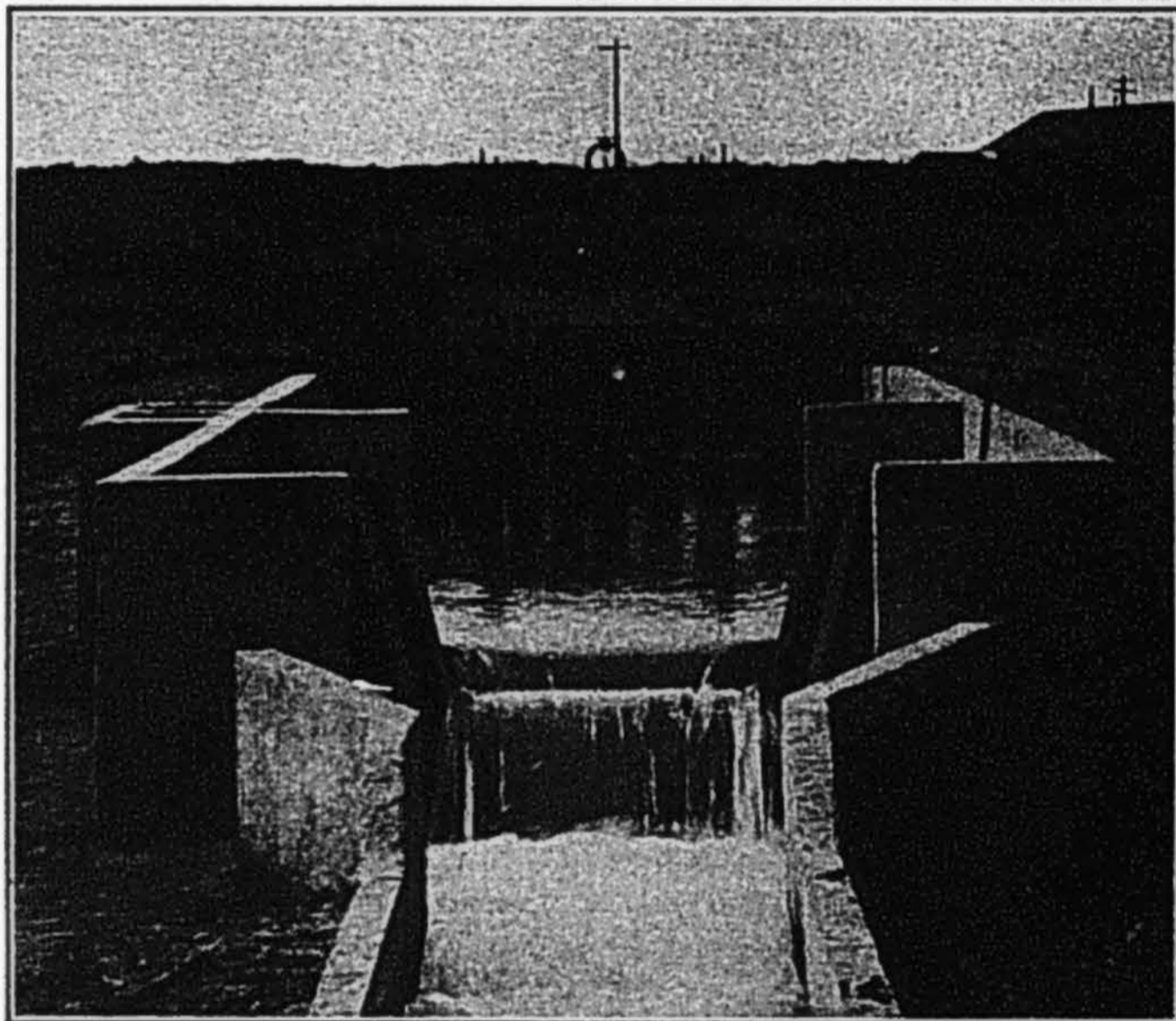

Fig. 2.—Concrete standardizing box, Davis Field Laboratory

devices. Water from the reservoir is brought into the box with a downward flow into a slightly suppressed pool and must pass from the pool over a bulkhead 12 inches high and through a baffle before reaching the weir or orifice set in the opening in the partition already referred to. Four pieces of 4-inch channel iron 9 feet long are set directly below the baffle board and when desired furnish a spill with an aggregate length of 72 feet for aiding in keeping a constant head over the standard weir or orifice. When planning the installation this was considered a necessary part of the control on account of the water supply from the reservoir being fed to the standardizing box

under a diminishing head. The channel-iron spills all discharge through a 6-inch iron pipe into a well on the side of the main box out of which water spilled can be measured through a circular orifice of any necessary size. In the tests thus far made this spilling device has not been used because it has not been found necessary to maintain an exactly constant flow during the tests. The elevation of the bottom of this box is 90.6 feet above datum.

(3) Concrete main ditch 3 feet wide, 2 feet deep, and 80 feet long, with vertical sides, leading from the lower end of the standardizing box. All devices other than the Azusa, Gage, and Riverside hydrants lead from this main ditch. The elevation of the ditch is 90.6 feet above datum and it has a slope of 0.10 foot in 100 feet.

(4) Twelve-inch concrete pipe leading from the bottom of the standardizing box to the Azusa, Gage, and Riverside hydrants, the flow into this pipe being controlled by a 12-inch K-T valve set flush with the bottom of the standardizing box.

MEASURING DEVICES FOR UNDERGROUND DISTRIBUTION SYSTEMS

When irrigation water is distributed in underground pipes measurement is usually accomplished at the hydrant through which the water is brought to the surface. Three of the measuring hydrants used in southern California have been installed at the field laboratory.

AZUSA HYDRANT

This hydrant (Figs. 3 and 4) is chiefly used in the vicinity of Azusa, Calif., and provides for measurement through one or more orifices on the center of which a pressure head of 4 inches is maintained by means of a sheet-iron spill crest set at right angles to the orifice plate. The hydrant is in the form of a concrete box placed over the supply pipe line. The openings in the orifice plate are 4 inches high and $2\frac{1}{2}$, $3\frac{3}{4}$, $6\frac{1}{4}$, and $12\frac{1}{2}$ inches wide, giving areas of 10, 15, 25, and 50 square inches, respectively. When the water surface on the upper side of these openings is held 4 inches above their centers they will discharge respectively, 10, 15, 25, and 50 inches. By using different combinations of these openings several different amounts up to 100 inches can be measured. The water enters through the pipe shown in the drawing (Fig. 4). The orifices for the desired amounts to be turned out are opened and the others closed with slides.

By adjusting the gate below the spillway the water can be brought to the crest of the spillway, the area of the orifices in square inches being then equal to the number of inches turned out. If the water rises above the openings a large part of the increase will be carried back to the supply line over the spillway, but any increase in depth on the openings will also increase the amount turned out.

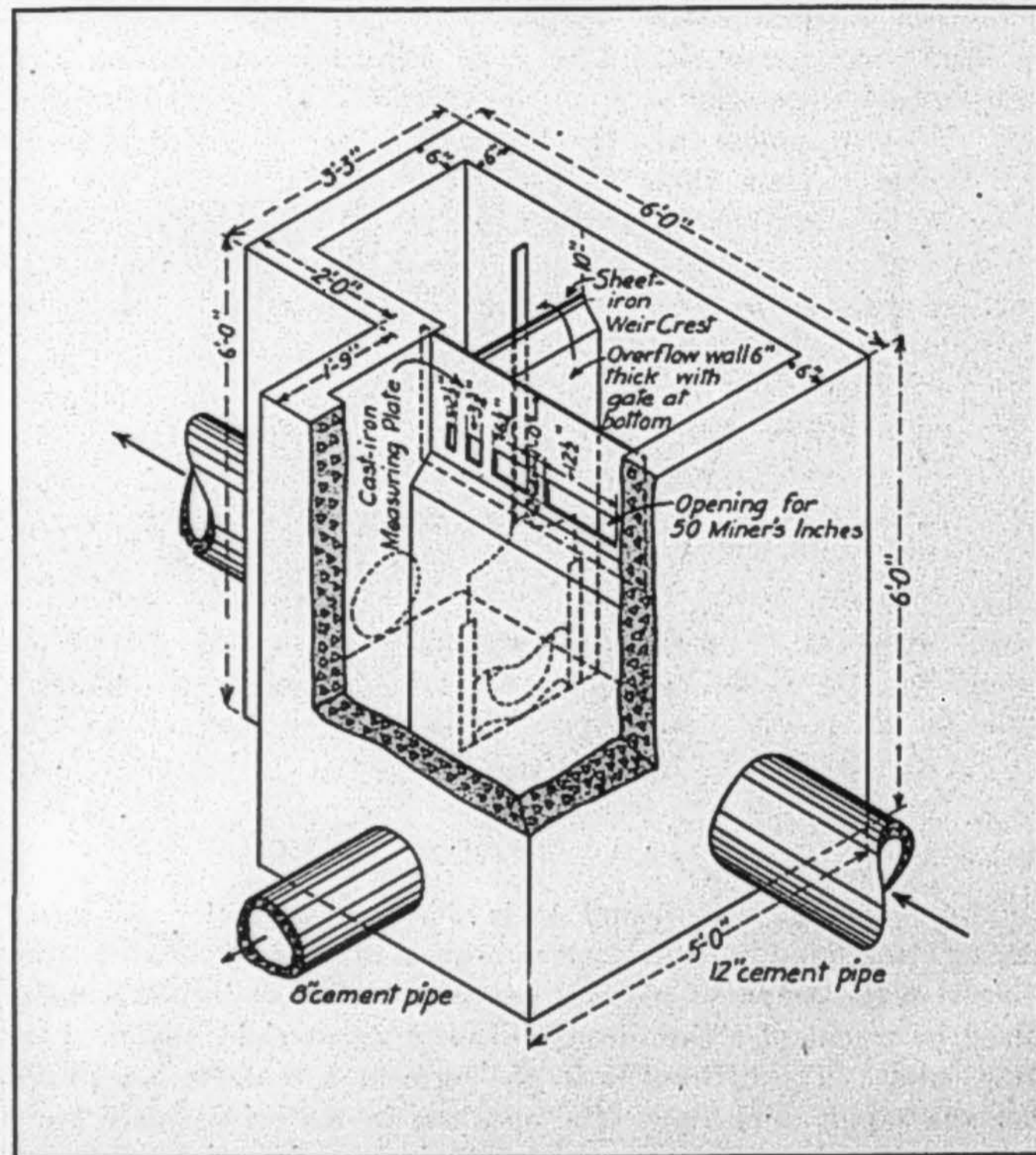

Fig. 3.—Drawing of Azusa hydrant

The Azusa box as shown has walls 6 inches thick, all sides being vertical and flat. The forms required in making are therefore simple. The box contains 78.3 cubic feet of concrete. This can be made of 1 part cement to 4 parts coarse sand. As the walls are 6 inches thick it is better to use some gravel when it can be obtained. A good mixture when using gravel is 1 part cement, 3 parts sand, and 4 parts

gravel. The gravel should not be larger than $1\frac{1}{2}$ inches. The concrete for this box including forms will cost from \$18 to \$20 under a large contract and about \$30 if made singly. The plate with the openings and slides can be bought already made for \$12 from foundries in the vicinity of the places the hydrant is used. The gate can be any of the usual types of slide gate.

The average of all tests made of this hydrant showed the amounts in inches being carried through the openings to be 1 per cent more than their area in square inches. This difference includes all errors in the measurements so that these openings are seen to be very accurate. The tests showed all openings or combinations of openings to be equally accurate. The box will therefore measure as accurately as is required. The openings are not as closely adjustable to the amounts turned out, however, as they are in the case of the box of the Riverside Water Co.

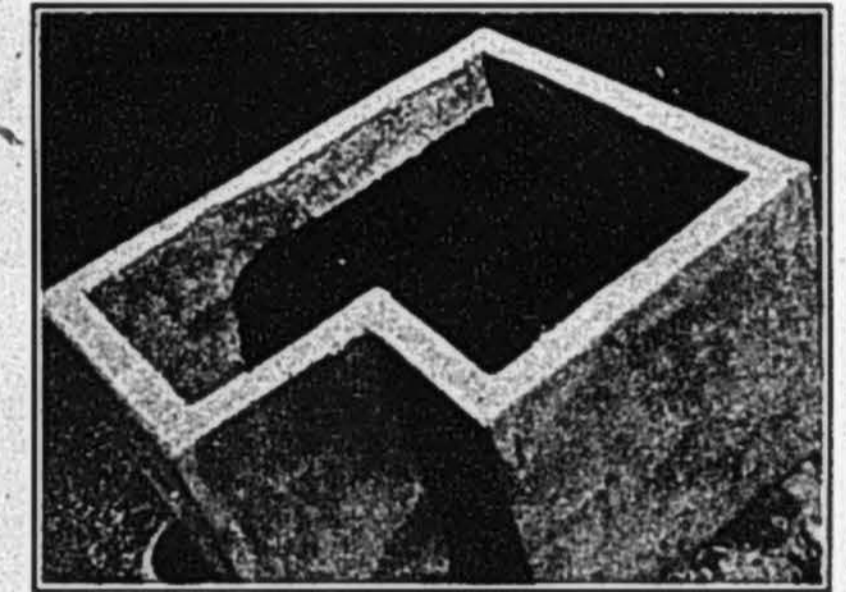

Fig. 4.—Photograph of Azusa hydrant from above

GAGE HYDRANT

This hydrant (Figs. 5 and 6) has been developed, and, so far as is known, is only used by the Gage Canal Company, of Riverside, Calif. The main box is of mortar 2 inches thick and is made in the material yard and seasoned before setting. The concrete is made of 1 part cement and 3 parts coarse sand, mixed quite dry and thoroughly tamped. The bottom is cast separately and the top cemented to it in the field. The dimensions of the box are shown in the drawing. The weir crest consists of $\frac{1}{8}$ -inch by $1\frac{1}{2}$ -inch iron cemented to the sides, giving a final opening of 10 inches wide and $10\frac{1}{2}$ inches high. One man makes 2 boxes in a day. In making one box $2\frac{3}{4}$ sacks of cement are used. The company charges \$10 per box, with weir, not installed. The outlet chamber into which the water goes after passing over the weir is omitted from the drawing. In the hydrant installed at Davis a half section of 18-inch pipe is used for this purpose, as shown in the photograph. When the hydrant is not in use the valve

shown in the drawing at the end of the pipe is kept closed. When in use the valve is opened to the desired extent and the water rises from the valve and flows over the weir. The amount flowing is determined by measuring the depth of the water in the box above the crest of the weir and either figuring the discharge or taking it from a table. The depth of water on the crest is usually obtained by measurement from a bracket set level with the crest at the back side of the box. After the water passes the weir it can be caught in various ways and carried to its point of use. Generally this is done by letting it

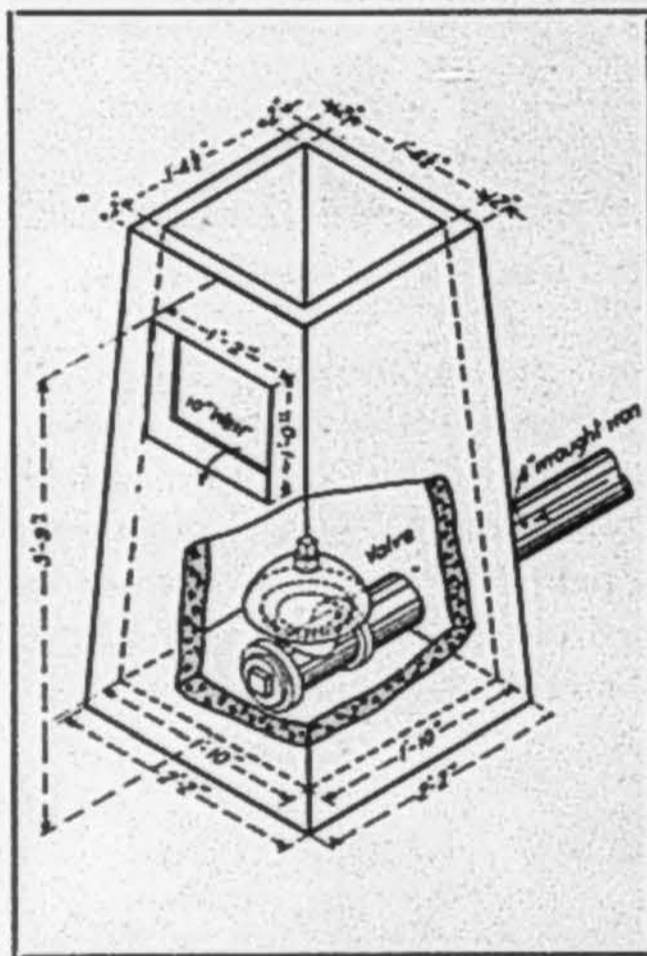

Fig. 5.—Drawing of Gage hydrant



Fig. 6.—Photograph of Gage hydrant

fall to a pipe below and carrying it through pipe distributing systems or directly into a distributing flume.

In the tests with this hydrant it was found that the amount of water discharged for any given depth was greater with this box than it would be with a standard 10-inch weir. This is due to the nearness of the sides of the box to the sides of the weir and to the velocity conditions in the box. The amount of this difference increases as the head increases, being as much as 35 per cent at the higher heads. In practice the principal source of error in using this box will be the difficulty in measuring the depth over the weir closely. In the tests this was done with special gages enclosed in stilling cans, but even then it was difficult to get the depths correctly. Measurements in open water with a rule would vary much more.

RIVERSIDE BOX

This is shown in figures 7 and 8. It consists of a shallow box set over the end of the delivery pipe line. The water enters through the bottom of the box and is measured out through an adjustable cast-

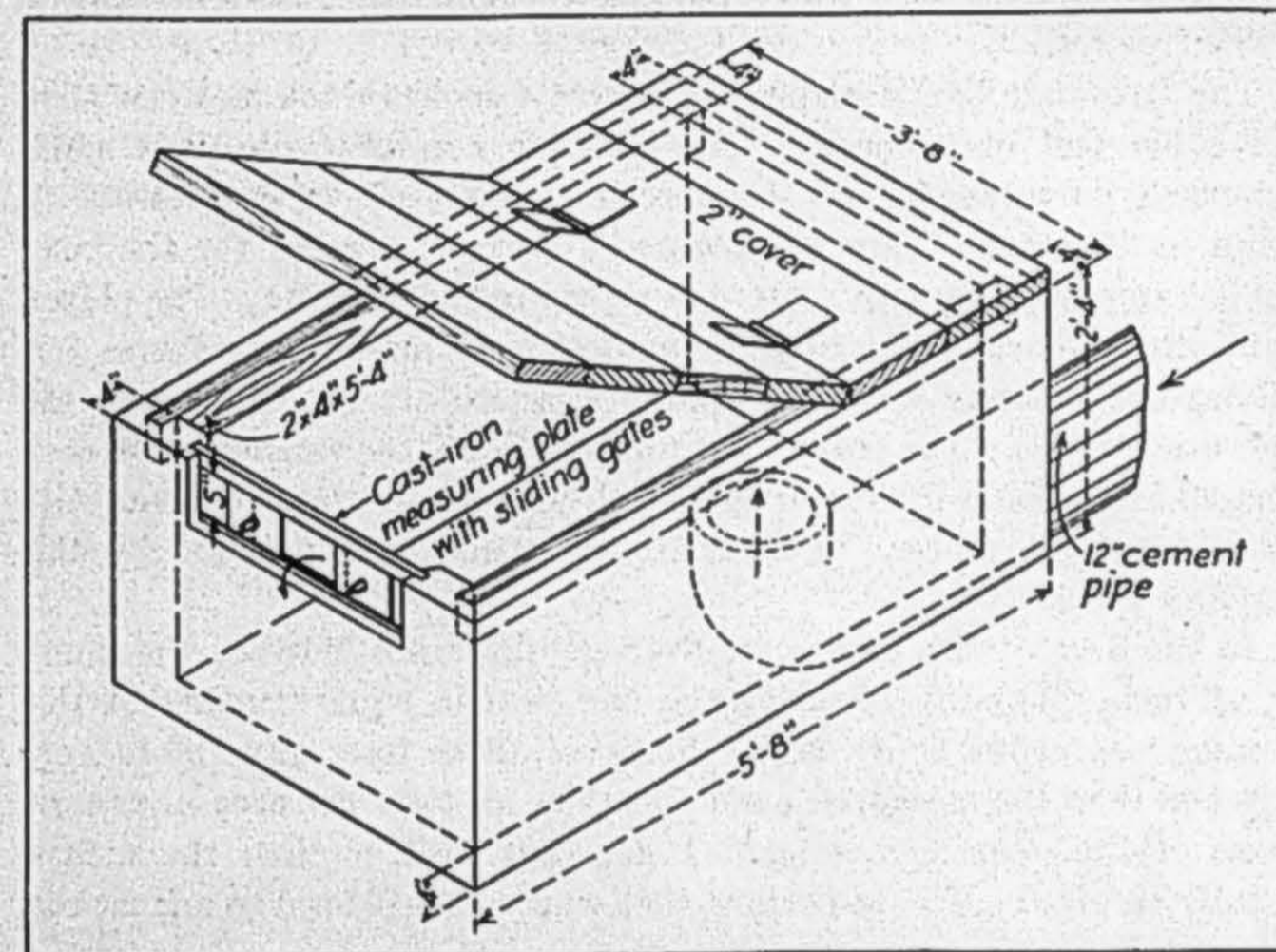

Fig. 7.—Drawing of Riverside measuring box

iron measuring plate in the end. The opening in this plate is 5 inches high and by moving the iron slide gates it can be varied in width up to 14 inches. With this gate, however, there is no provision for holding a constant head or pressure above the opening. The top of the plate is 4 inches above the center of the opening. Thus if the slides are set so as to hold the water surface at the top of this plate the discharge in inches will equal the area of the opening in square inches. The area of the opening is the width in inches multiplied by 5. Marks one inch apart are

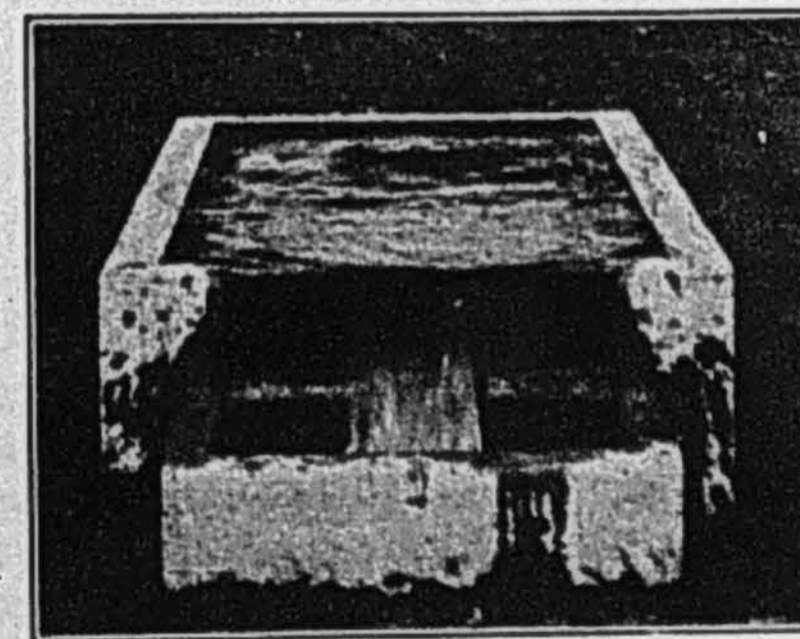

Fig. 8.—Photograph of Riverside measuring box

made on the plate to assist in measuring the width. The method of carrying the measured water away is not shown on the drawing but is shown in the photograph. The water is usually dropped into another pipe system to be distributed for use. Care should be taken so to place the outlet chamber that water passing through the gate will always have a free fall.

The Riverside box is made of concrete 4 inches thick and contains 18.4 cubic feet of concrete. The concrete can be made of 1 part cement, 3 parts sand, and 4 parts of gravel not larger than $1\frac{1}{2}$ inches in diameter. This will require 3 sacks of cement for the box. The box can be made with a cover as shown in the drawing. The plates containing the orifice can be purchased already made. The forms for making the concrete walls are simple as there are no curves and all sides are vertical. The cost of the plate is \$2.25, the concrete will cost from \$3.50 to \$5.00 for material, forms, and labor, and the cover will cost about \$1.50 more. These boxes are made and installed by the company for \$10.00.

In the tests of this device the average difference between the number of inches actually received and the area in square inches of the opening was about 2 per cent. Some of these tests gave more and some less than the measured amounts. For all tests the area in square inches of the opening averaged 1 per cent greater than the inches actually received. The tests show that where care is used to adjust the width of the opening to the amount running this box will measure water very closely.

While the Riverside box is of the type used on underground pipe systems, the measuring plate used in it can be set in open ditches if desired. The box is sufficiently large so that the water passes through it without much agitation and can be brought to the top of the opening plate quite closely. There will generally be some leakage around the slides but these can be wedged tight if necessary. The box shown will measure amounts up to 75 inches.

FOOTE INCH BOX

This structure is shown in figures 9 and 10. It consists of a box having two principal parts, the larger part being merely a section of flume set in the main channel of the supply lateral and the smaller a spill and measuring chamber. On one side of this smaller portion there is a discharge opening in which a slide moves horizontally. The other side of this side box or flume is a spillway. Gates are arranged as

shown at the upper end so that water can be turned into this side box as desired. This is done by putting in as many flash boards across the supply lateral as are needed to crowd the water into the side box. The slide on the miner's inch opening is then set so that the water in this side box stands level with the crest of the spillway. The crest of this spillway is placed 4 inches above the center of the opening. The opening is 4 inches high. Thus when the water stands level with the spillway the width of the opening of the slide multiplied by four gives the number of inches flowing.

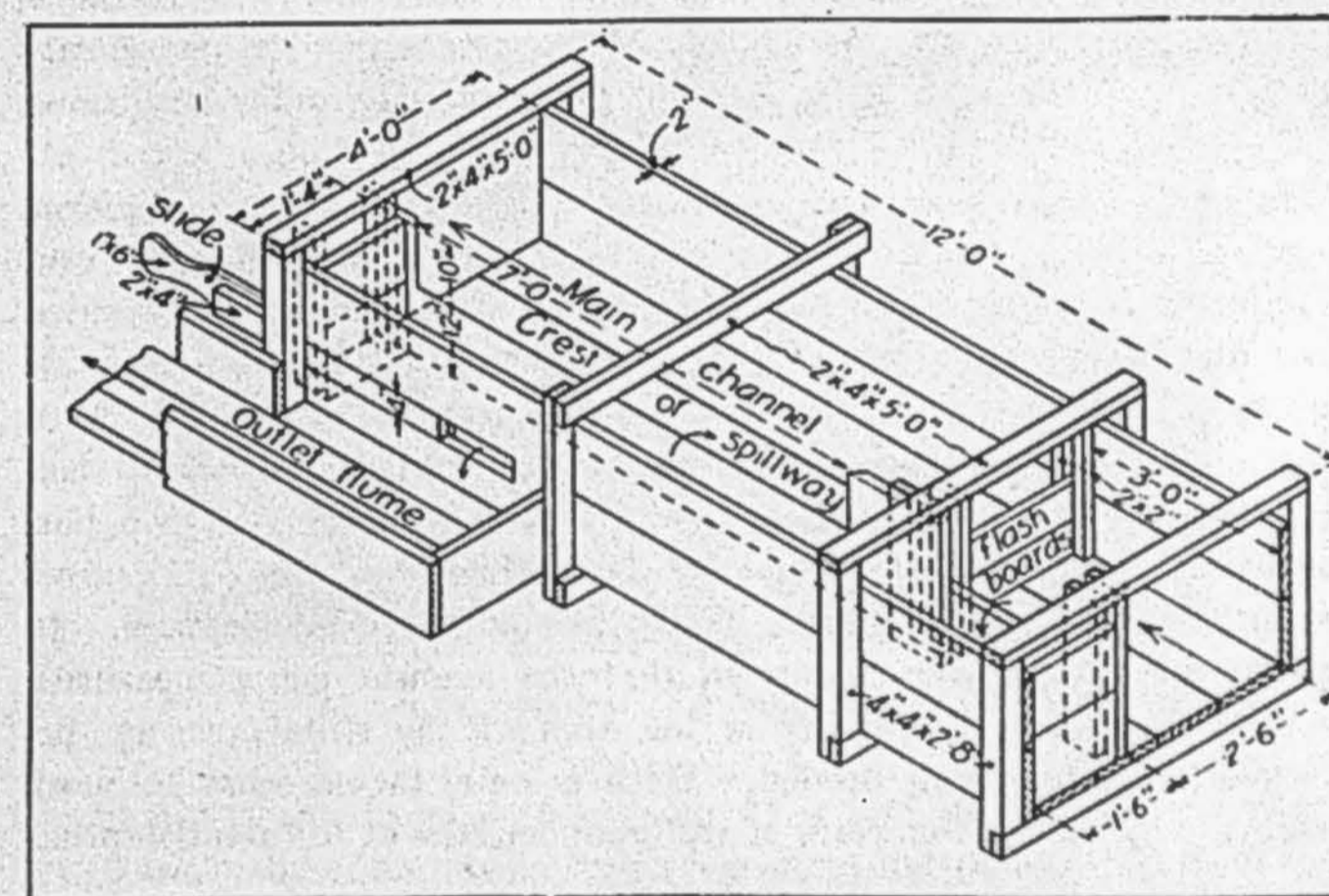

Fig. 9.—Drawing of Foote inch box

This box does not require much fall in the supply lateral. The crest of the spillway should be set so that the water in the main channel will be at least 3 to 4 inches below it. The water in the ditch above can then be checked up with the flashboards until the water in the side box comes level with its crest. The ditch into which the measured water is turned must be lower than the main channel by over one foot. The water in the outlet flume should not rise within about 3 inches of the bottom of the slide opening. If the water in the outlet flume does rise above the bottom of the slide opening, the conditions for measurement are changed and the discharge is smaller than with free fall.

In the tests of this device the amount of water supposed to have been passed, as measured by taking the area of the slide openings,

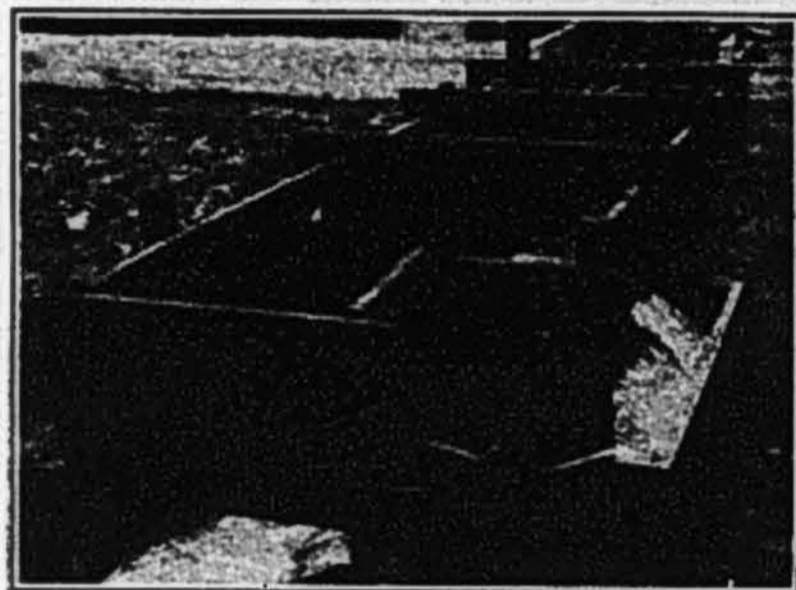

Fig. 10.—Photograph of Foote inch box

averaged 4 per cent greater than was actually run. The error did not vary with the amount of the discharge. From these tests it appears that the slide can be set within an average 4 per cent of correct if care is used.

This box will measure water up to 150 inches satisfactorily under conditions to which it is adapted, although it is not in general an economical box to use.

It requires as much fall from the supply lateral as a weir, besides some fall in the lateral itself. It also takes as much lumber as is required for a check and turnout in the supply later and a weir below. The weir will give more satisfactory measurements and has no slides to leak if too loose or to stick if too tight. The inch box was used a good deal in the earlier days when water was measured mainly for mining but is built but little now for irrigation use. It has one advantage over a weir in that the amount being measured can be determined directly from the area of the slide opening, no tables or figuring being needed. With a weir, tables must be used giving the discharge for weirs of different lengths at different depths.

WEIRS*

In sections where the irrigated lands have a considerable slope, so that water can very easily be led from the supply ditches or laterals

* No attempt is made in this bulletin to present a broad and full discussion of weirs, only enough being given to enable the farmer who is unfamiliar with water measurement to understand their use in irrigation. The weir tables that are given are those that are generally used in irrigation practise and are therefore based on the well-known formulas. Engineers have recognized that these formulas do not apply throughout the wide range of conditions met in the field and for that reason numerous engineers have made experiments designed to correct the formulas for the conditions to which the Francis and other formulas do not properly apply. The Office of Experiment Stations, in co-operation with the Colorado Agricultural Experiment Station, has installed and fully equipped at Fort Collins, Colo., an hydraulic laboratory in which a large number of such experiments with weirs have recently been made by V. M. Cone, irrigation engineer, and assistants.

to the land without having to check the water nearly as high as the ditch banks, some form of weir is the most common type of measuring device. Taken singly, however, a weir, like other non-mechanical meters, measures the rate of flow and does not indicate the total quantity delivered. In conjunction with a water register (Fig. 26), which graphically records the depth of water passing over the weir, or in conjunction with such a device as the Hanna meter (Fig. 25), which may be arranged to read directly in acre-feet, measurement by means of a weir gives entirely satisfactory results. Where conditions permit its use the weir is thus far the generally accepted device for measuring

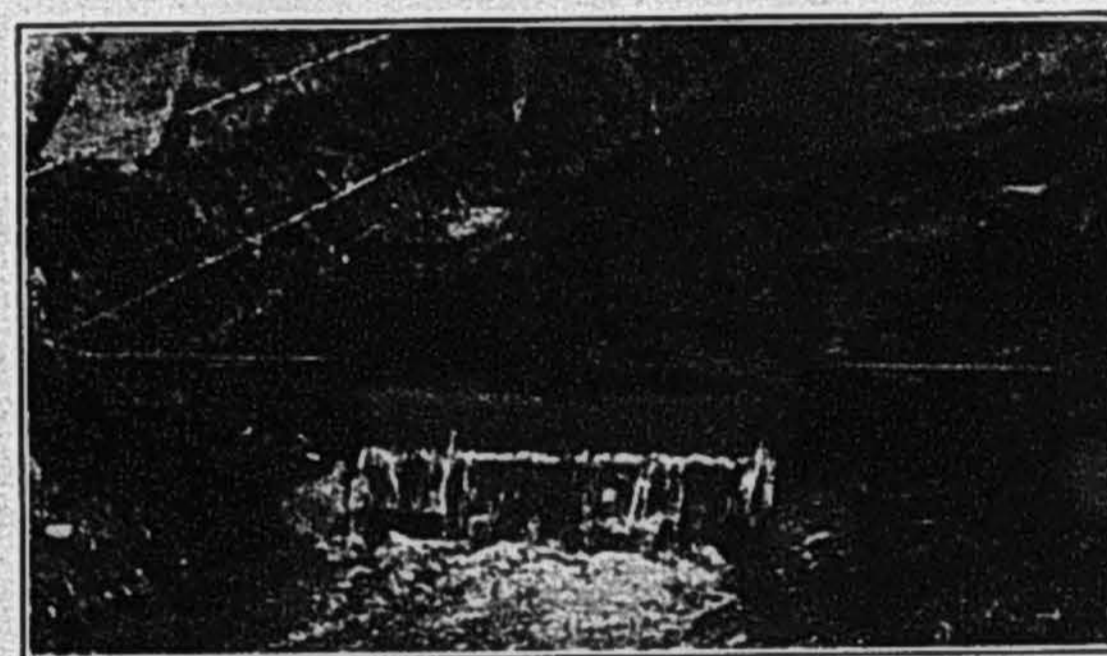

Fig. 11.—Measuring water with a small wooden Cipolletti weir

lateral diversions from main canals. It is also an accepted standard device for testing the rate of flow from pumping plants, just as it has been the standard device in the tests that have been made of the various devices installed at Davis. Small movable weirs (Fig. 11) are convenient for use by farmers for measuring the water carried in their individual ditches or discharged by pumping plants.

Three types of weirs are chiefly in use in irrigation practise; viz: the Cipolletti weir, the weir extending the entire distance across the ditch or flume carrying the water measured, known as the weir without end contractions, and the rectangular weir that does not extend entirely across the ditch or flume, known as the rectangular weir with end contractions. The first two only of these are installed at Davis and described in this bulletin.

Briefly, a weir is merely a board or other crest set across a stream or other water channel and over which the water carried is made to flow. If the velocity of the water directly above the weir, known as

the velocity of approach, is very small and due only to the falling of the water over the weir crest, the quantity of water passing depends entirely on the depth of the water over the crest and the length of the crest. In the case of the rectangular weir with end contractions the discharge is not proportional to the length of the weir crest. Such a weir is not, however, described in this bulletin. In fact, the discharge is not precisely proportional to the length in the case of the weir without end contractions, but is so nearly so as to involve no error of consequence by assuming it to be. As tables have been prepared that show the quantity passing over both a Cipolletti weir and a weir without end contractions (as well as other types of weirs), measurement with a weir only involves measuring the depth of water over the weir crest and reference to the appropriate table to determine the quantity passing for the given depth and crest length.

CIPOLLETTI WEIR

This weir, as installed at Davis, is shown in figures 12 and 13. The length of weir and size of box to make are of course dependent on the quantity of water to be measured. In general, it may be said that a Cipolletti weir should be small enough so that the amount of water to

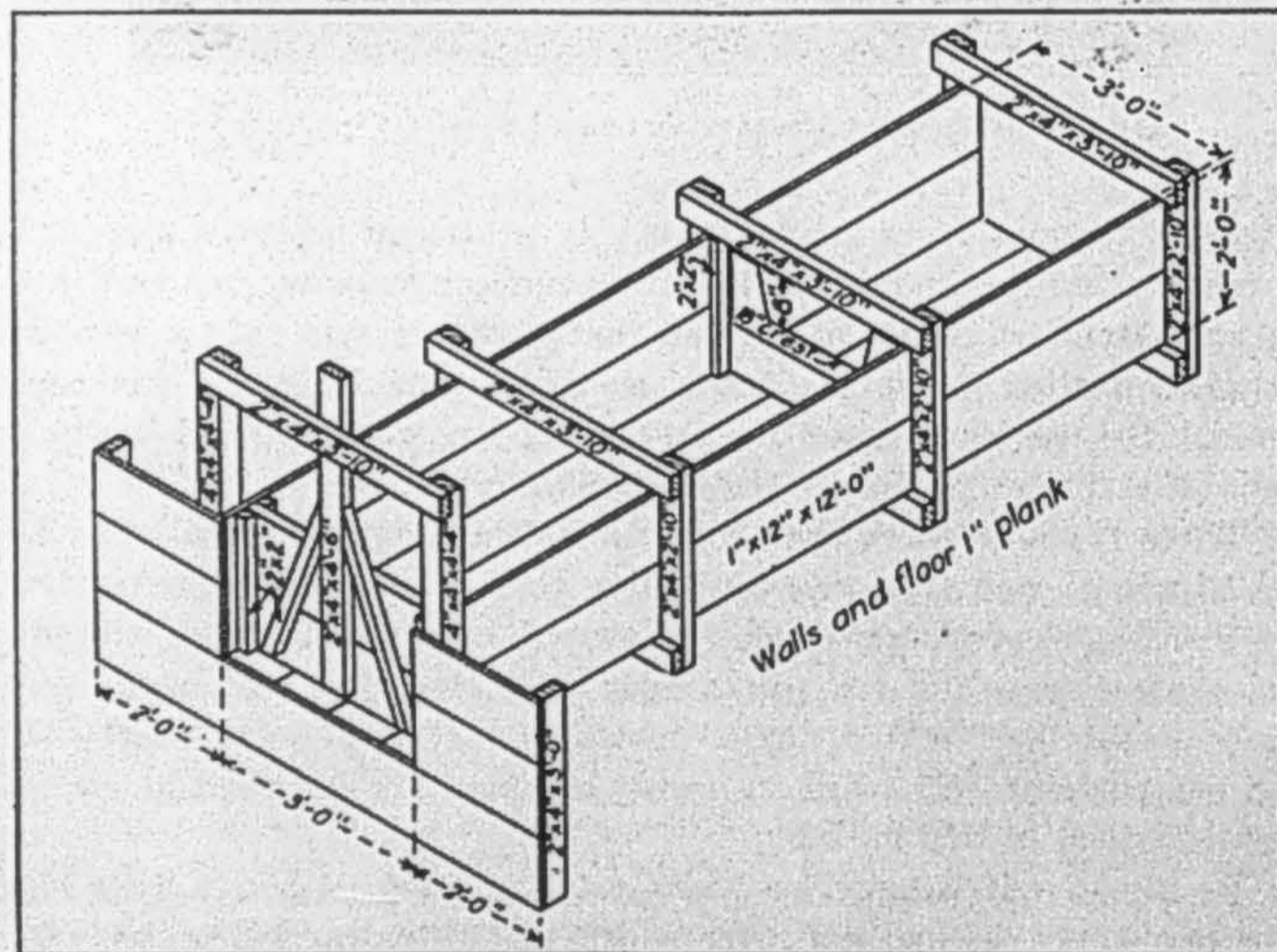

Fig. 12.—Drawing of Cipolletti weir and weir box

be measured will never give less than a depth of one inch over the weir crest, and large enough so that the depth will never need to be much more than one-third of the crest length. Care should also be taken to see that the weir crest is long enough so that the water can be measured without raising it higher over the weir crest than is permitted by the available fall. A number of other conditions are usually laid down as necessary for the weir. The most important of these, briefly paraphrased, follow:

1. The distance from the crest of the weir to the bottom of the canal or floor of the weir box should be at least three times the depth of water on the weir. That is, with an 18-inch weir intended to measure up to 2 cubic feet per second, which requires a depth on the weir of about 6 inches, the crest of the weir should be about 18 inches above the floor.
2. The distance from the ends of the weir crest to the sides of the weir box should be about twice the depth of the water on the weir, or, say, from 10 to 12 inches in the case of an 18-inch weir measuring about 2 cubic feet per second.
3. The bottom and sides of the weir notch should be bevelled on the down-stream side to give a narrow edge. The use of a galvanized iron crest is quite common and very satisfactory, but not necessary. Sometimes thin pieces of strap iron are fastened on the up-stream side of the weir notch. In other cases the board in which the weir notch is cut is merely bevelled down to a crest thickness of one-eighth or one-quarter of an inch.
4. Water should not be allowed to approach the weir with a velocity exceeding 6 inches per second. Also, it should flow to the weir in a smooth stream free from eddies or swirls. Both of these conditions are most easily met by placing the weir in a straight section of the ditch.
5. The water passing over the weir should, if possible, have a free over-fall. Where necessary, however, it may rise to the level of the weir crest without appreciable error in the measurement.

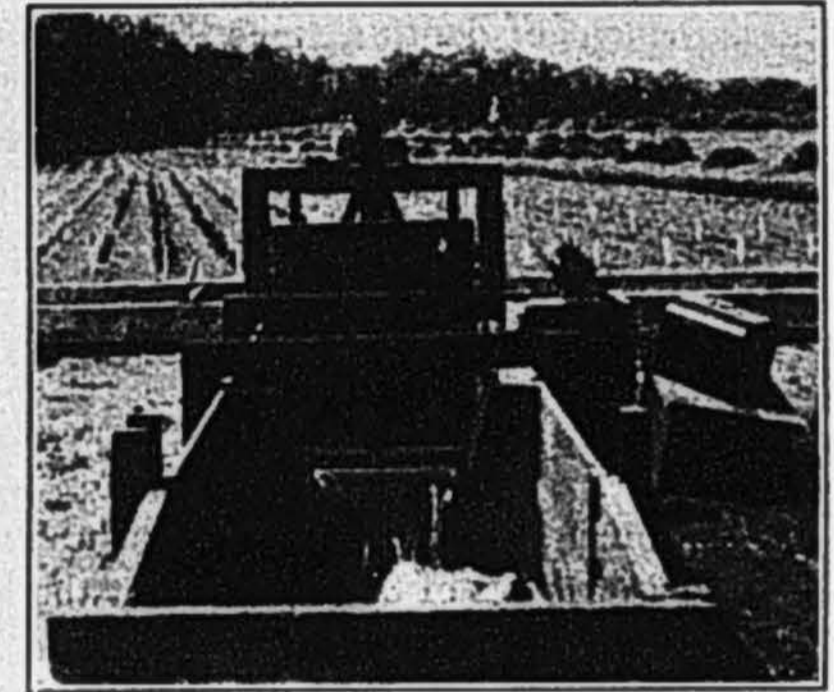

Fig. 13.—Photographs of Cipolletti weir and Hanna meter

6. The depth of water on the weir crest must be measured sufficiently above the weir to be free from the downward curve of the water as it passes over the weir. For convenience in making this measurement of depth a stake with its top level with the crest of the weir is usually set at one side of the ditch 2 or 3 feet above the weir, the measurements of depth then being made from the top of this stake to the top of the water.

CIPOLLETTI WEIR TABLES

The tables below give the discharge over Cipolletti weirs from 1 to 5 feet long. For lengths of from 1 to 2 feet the length of weir crest is given in inches and the depths in inches and feet (Table 1). For weirs with crest lengths of 3, 4, and 5 feet the lengths and depths are given in feet only (Table 2). If it is desired to measure the discharge in inches instead of cubic feet per second, multiply the cubic feet per second given in the table by 50, if the old customary California miner's inch is desired, or by 40, if it is desired to use the statute miner's inch of California.

TABLE 1

DISCHARGE OF CIPOLLETTI WEIRS 12 TO 24 INCHES LONG IN CUBIC FEET PER SECOND, COMPUTED FROM FORMULA $Q = 3.367 LH^{\frac{3}{2}}$

Head, H	Length of weir L, inches												
	12	13	14	15	16	17	18	19	20	21	22	23	24
In.													
1/2	.03	.03	.04	.04	.04	.04	.04	.04	.04	.05	.05	.06	.06
5/8	.04	.04	.05	.05	.05	.06	.06	.06	.07	.07	.07	.08	.08
3/4	.05	.05	.06	.06	.07	.07	.08	.08	.08	.09	.09	.10	.10
7/8	.07	.08	.08	.09	.09	.10	.10	.11	.12	.12	.13	.13	.13
1	.08	.09	.09	.10	.11	.11	.12	.13	.13	.14	.15	.15	.16
1 1/8	.10	.11	.12	.12	.13	.14	.15	.16	.17	.18	.18	.19	.19
1 1/4	.11	.12	.13	.14	.15	.16	.17	.17	.18	.19	.20	.21	.23
1 1/2	.13	.14	.15	.16	.17	.18	.20	.21	.22	.23	.24	.25	.26
1 5/8	.15	.16	.18	.19	.20	.21	.22	.24	.25	.26	.28	.29	.30
1 3/4	.17	.18	.20	.21	.23	.24	.25	.27	.28	.30	.31	.33	.33
1 7/8	.19	.21	.22	.24	.25	.27	.28	.30	.32	.33	.35	.36	.38
1 3/4	.21	.23	.24	.26	.28	.30	.31	.33	.35	.37	.38	.40	.42
2	.23	.25	.27	.29	.31	.33	.34	.36	.38	.40	.42	.44	.46
2 1/8	.25	.27	.29	.31	.33	.35	.38	.40	.42	.44	.46	.48	.50
2 1/4	.27	.29	.32	.34	.36	.38	.41	.43	.45	.47	.50	.52	.55
2 3/8	.30	.32	.35	.38	.40	.42	.45	.48	.50	.52	.55	.57	.59
2 1/2	.32	.35	.37	.40	.43	.45	.48	.51	.53	.56	.59	.61	.64
2 5/8	.34	.37	.40	.42	.45	.48	.52	.55	.58	.61	.63	.66	.69
2 3/4	.37	.40	.43	.46	.49	.52	.55	.59	.62	.65	.68	.71	.74
2 7/8	.40	.43	.47	.50	.53	.56	.59	.63	.67	.70	.73	.76	.79
3	.42	.46	.49	.52	.56	.60	.63	.66	.70	.74	.77	.80	.84
3 1/8	.45	.49	.52	.56	.60	.64	.67	.71	.75	.79	.82	.86	.89

TABLE 1—(Continued)

DISCHARGE OF CIPOLLETTI WEIRS 12 TO 24 INCHES LONG IN CUBIC FEET PER SECOND, COMPUTED FROM FORMULA $Q = 3.367 LH^{\frac{3}{2}}$

Head, H		Length of weir L, inches												
In.	Ft.	12	13	14	15	16	17	18	19	20	21	22	23	24
3¼	.271	.47	.51	.55	.59	.63	.67	.71	.74	.78	.82	.86	.90	.95
3½	.281	.50	.54	.58	.62	.67	.71	.75	.79	.83	.88	.92	.96	1.00
3¾	.292	.53	.57	.62	.66	.71	.75	.80	.84	.88	.93	.97	1.02	1.06
3⅞	.302	.56	.61	.65	.70	.75	.79	.84	.89	.93	.98	1.03	1.07	1.12
3⅞	.312	.59	.64	.69	.74	.79	.84	.88	.93	.98	1.03	1.08	1.13	1.17
3⅞	.323	.62	.67	.72	.78	.83	.88	.93	.98	1.03	1.08	1.14	1.19	1.24
4	.333	.65	.70	.76	.81	.87	.92	.97	1.03	1.08	1.14	1.19	1.24	1.29
4¼	.344	.68	.74	.79	.85	.91	.96	1.02	1.08	1.13	1.19	1.25	1.30	1.36
4¼	.354	.71	.77	.83	.89	.95	1.01	1.06	1.12	1.18	1.24	1.30	1.36	1.42
4½	.365	.74	.80	.86	.92	.99	1.05	1.11	1.17	1.23	1.30	1.36	1.42	1.48
4½	.375	.77	.84	.90	.96	1.03	1.09	1.16	1.22	1.28	1.35	1.41	1.48	1.55
4¾	.385	.80	.87	.93	1.00	1.07	1.13	1.21	1.27	1.33	1.40	1.47	1.54	1.61
4¾	.396	.84	.91	.98	1.05	1.12	1.19	1.26	1.33	1.40	1.47	1.54	1.61	1.68
4¾	.406	.87	.94	1.01	1.09	1.16	1.23	1.31	1.38	1.45	1.52	1.60	1.67	1.74
5	.417	.91	.99	1.06	1.14	1.21	1.29	1.36	1.44	1.52	1.59	1.67	1.74	1.81
5¼	.427	.94	1.02	1.10	1.18	1.25	1.33	1.41	1.49	1.57	1.64	1.72	1.80	1.88
5¼	.438	.98	1.06	1.14	1.22	1.30	1.38	1.46	1.55	1.63	1.72	1.80	1.88	1.95
5½	.448	1.01	1.09	1.18	1.26	1.35	1.43	1.51	1.60	1.68	1.77	1.85	1.93	2.02
5½	.458	1.04	1.13	1.21	1.30	1.39	1.47	1.56	1.65	1.73	1.82	1.91	2.00	2.09
5½	.469	1.08	1.17	1.26	1.35	1.44	1.53	1.62	1.71	1.80	1.89	1.98	2.07	2.16

TABLE 1—(Continued)

DISCHARGE OF CIPOLLETTI WEIRS 12 TO 24 INCHES LONG IN CUBIC FEET PER SECOND, COMPUTED FROM FORMULA $Q = 3.367 LH^{\frac{3}{2}}$

Head, H		Length of weir L, inches												
In.	Ft.	12	13	14	15	16	17	18	19	20	21	22	23	24
5¾	.479	1.12	1.21	1.31	1.40	1.49	1.58	1.67	1.77	1.87	1.96	2.05	2.14	2.23
5¾	.490	1.15	1.25	1.34	1.44	1.53	1.63	1.73	1.82	1.92	2.01	2.11	2.21	2.31
6	.500	1.19	1.29	1.39	1.49	1.59	1.68	1.78	1.88	1.98	2.08	2.18	2.28	2.38
6¼	.510	1.33	1.43	1.53	1.64	1.74	1.84	1.94	2.04	2.15	2.25	2.35	2.45
6¼	.521	1.37	1.48	1.58	1.69	1.79	1.90	2.01	2.11	2.22	2.32	2.43	2.53
6½	.531	1.41	1.52	1.62	1.73	1.84	1.95	2.06	2.17	2.28	2.38	2.49	2.61
6½	.542	1.46	1.57	1.68	1.80	1.91	2.02	2.13	2.24	2.36	2.47	2.58	2.69
6¾	.552	1.61	1.72	1.84	1.96	2.07	2.18	2.30	2.42	2.53	2.64	2.76
6¾	.562	1.66	1.78	1.89	2.01	2.13	2.25	2.37	2.48	2.60	2.72	2.84
6¾	.573	1.70	1.83	1.95	2.07	2.19	2.31	2.43	2.56	2.68	2.80	2.92
7	.583	1.75	1.88	2.00	2.12	2.25	2.38	2.50	2.62	2.75	2.88	3.00
7¼	.594	1.92	2.05	2.18	2.31	2.44	2.56	2.69	2.82	2.95	3.08
7¼	.604	1.98	2.11	2.24	2.37	2.50	2.63	2.76	2.90	3.03	3.16
7½	.615	2.03	2.17	2.30	2.44	2.58	2.71	2.85	2.98	3.12	3.25
7½	.625	2.08	2.22	2.36	2.50	2.64	2.78	2.92	3.06	3.20	3.33
7¾	.635	2.28	2.42	2.56	2.70	2.84	2.99	3.13	3.27	3.41
7¾	.646	2.33	2.48	2.62	2.77	2.91	3.06	3.20	3.35	3.50
7¾	.656	2.38	2.53	2.68	2.83	2.98	3.13	3.28	3.43	3.58
8	.667	2.44	2.60	2.75	2.90	3.06	3.21	3.36	3.51	3.67
8¼	.677	2.65	2.81	2.96	3.12	3.28	3.43	3.59	3.75

TABLE 1—(Concluded)

DISCHARGE OF CIPOLLETTI WEIRS 12 TO 24 INCHES LONG IN CUBIC FEET PER SECOND, COMPUTED FROM FORMULA $Q = 3.367 L H^{3/2}$

Head, H		Length of weir L, inches												
In.	Ft.	12	13	14	15	16	17	18	19	20	21	22	23	24
8 1/4	.688	2.72	2.88	3.04	3.20	3.36	3.52	3.68	3.84
8 3/8	.698	2.79	2.95	3.12	3.28	3.44	3.61	3.77	3.93
8 1/2	.708	2.84	3.01	3.18	3.34	3.51	3.68	3.85	4.01
8 5/8	.719	3.08	3.25	3.42	3.59	3.76	3.94	4.11
8 3/4	.729	3.14	3.31	3.49	3.66	3.84	4.02	4.19
8 7/8	.740	3.22	3.40	3.58	3.76	3.94	4.12	4.29
9	.750	3.28	3.46	3.64	3.82	4.01	4.19	4.37
9 1/8	.760	3.53	3.72	3.90	4.09	4.28	4.46
9 1/4	.771	3.61	3.80	3.99	4.18	4.37	4.56
9 3/8	.781	3.67	3.87	4.06	4.25	4.45	4.64

TABLE 2

DISCHARGE OF CIPOLLETTI WEIRS 3 TO 5 FEET LONG IN CUBIC FEET PER SECOND, COMPUTED FROM FORMULA $Q = 3.367 L H^{3/2}$

Head H, feet	Length of weir L, feet			Head H, feet	Length of weir L, feet			Head H, feet	Length of weir L, feet	
	3.0	4.0	5.0		3.0	4.0	5.0		4.0	5.0
.....	0.76	6.69	8.92	11.15	1.51	24.99	31.24
.....77	6.82	9.10	11.37	1.52	25.24	31.55
.....78	6.96	9.28	11.60	1.53	25.48	31.85
.....79	7.09	9.46	11.82	1.54	25.74	32.17
0.05	0.11	0.15	0.19	.80	7.23	9.64	12.04	1.55	25.99	32.49
0.06	.15	.20	.25	.81	7.36	9.82	12.27	1.56	26.24	32.80
0.07	.19	.25	.31	.82	7.50	10.00	12.50	1.57	26.49	33.12
0.08	.23	.30	.38	.83	7.64	10.18	12.73	1.58	26.75	33.44
0.09	.27	.36	.46	.84	7.78	10.37	12.96	1.59	27.00	33.75
0.10	.32	.43	.53	.85	7.92	10.55	13.19	1.60	27.25	34.07
0.11	.37	.49	.61	.86	8.06	10.74	13.42	1.61	27.51	34.39
0.12	.42	.56	.70	.87	8.20	10.93	13.66	1.62	27.77	34.71
0.13	.47	.63	.79	.88	8.34	11.12	13.90	1.63	28.03	35.04
0.14	.53	.70	.88	.89	8.48	11.31	14.13	1.64	28.29	35.36
0.15	.59	.78	.98	.90	8.62	11.50	14.37	1.65	28.54	35.68
0.16	.65	.86	1.08	.91	8.77	11.69	14.61	1.66	28.80	36.01
0.17	.71	.94	1.18	.92	8.91	11.88	14.85	1.67	29.07	36.33
0.18	.77	1.03	1.28	.93	9.06	12.08	15.10	1.68	29.33	36.66
0.19	.84	1.12	1.39	.94	9.20	12.27	15.34	1.69	29.59	36.99
0.20	.90	1.20	1.51	.95	9.35	12.47	15.59	1.70	29.85	37.32

TABLE 2—(Continued)

DISCHARGE OF CIPOLLETTI WEIRS 3 TO 5 FEET LONG IN CUBIC FEET PER SECOND, COMPUTED FROM FORMULA $Q = 3.367 LH^{3/2}$

Head H, feet	Length of weir L, feet			Head H, feet	Length of weir L, feet			Head H, feet	Length of weir L, feet	
	3.0	4.0	5.0		3.0	4.0	5.0		4.0	5.0
0.21	.97	1.30	1.62	.96	9.50	12.67	15.83	1.71	30.12	37.64
0.22	1.04	1.39	1.74	.97	9.65	12.86	16.08	1.72	30.38	37.98
0.23	1.11	1.48	1.86	.98	9.80	13.06	16.33	1.73	30.65	38.31
0.24	1.19	1.58	1.98	.99	9.95	13.26	16.58	1.74	30.91	38.64
0.25	1.26	1.68	2.10	1.00	10.10	13.47	16.83	1.75	31.18	38.97
0.26	1.34	1.78	2.23	1.01	13.67	17.09	1.76	31.45	39.31
0.27	1.42	1.89	2.36	1.02	13.87	17.34	1.77	31.72	39.64
0.28	1.50	2.00	2.49	1.03	14.08	17.60	1.78	31.98	39.98
0.29	1.58	2.10	2.63	1.04	14.28	17.86	1.79	32.25	40.32
0.30	1.66	2.21	2.77	1.05	14.49	18.11	1.80	32.52	40.66
0.31	1.74	2.32	2.90	1.06	14.70	18.37	1.81	32.80	41.00
0.32	1.83	2.44	3.05	1.07	14.91	18.63	1.82	33.07	41.34
0.33	1.92	2.55	3.19	1.08	15.12	18.90	1.83	33.34	41.68
0.34	2.00	2.67	3.34	1.09	15.33	19.16	1.84	33.61	42.02
0.35	2.09	2.79	3.49	1.10	15.54	19.42	1.85	33.89	42.36
0.36	2.18	2.91	3.64	1.11	15.75	19.69	1.86	34.16	42.70
0.37	2.27	3.03	3.79	1.12	15.96	19.96	1.87	34.44	43.05
0.38	2.37	3.16	3.94	1.13	16.18	20.22	1.88	34.72	43.40
0.39	2.46	3.28	4.10	1.14	16.39	20.49	1.89	34.99	43.74
0.40	2.56	3.41	4.26	1.15	16.61	20.76	1.90	35.27	44.09

TABLE 2—(Continued)

DISCHARGE OF CIPOLLETTI WEIRS 3 TO 5 FEET LONG IN CUBIC FEET PER SECOND, COMPUTED FROM FORMULA $Q = 3.367 LH^{3/2}$

Head H, feet	Length of weir L, feet			Head H, feet	Length of weir L, feet			Head H, feet	Length of weir L, feet	
	3.0	4.0	5.0		3.0	4.0	5.0		4.0	5.0
0.41	2.65	3.54	4.42	1.16	16.83	21.03	1.91	35.55	44.44
0.42	2.75	3.66	4.58	1.17	17.04	21.30	1.92	35.83	44.79
0.43	2.85	3.80	4.75	1.18	17.26	21.58	1.93	36.11	45.14
0.44	2.95	3.93	4.91	1.19	17.48	21.85	1.94	36.39	45.49
0.45	3.05	4.06	5.08	1.20	17.70	22.13	1.95	36.67	45.84
0.46	3.15	4.20	5.25	1.21	17.93	22.41	1.96	36.96	46.20
0.47	3.25	4.34	5.42	1.22	18.15	22.69	1.97	37.24	46.55
0.48	3.36	4.48	5.60	1.23	18.37	22.96	1.98	37.52	46.90
0.49	3.46	4.62	5.77	1.24	18.60	23.25	1.99	37.81	47.26
0.50	3.57	4.76	5.95	1.25	18.87	23.53	2.00	38.09	47.62
0.51	3.68	4.90	6.13	1.26	19.05	23.81	2.01	47.97
0.52	3.79	5.05	6.31	1.27	19.28	24.10	2.02	48.33
0.53	3.90	5.20	6.50	1.28	19.50	24.38	2.03	48.69
0.54	4.01	5.34	6.68	1.29	19.73	24.67	2.04	49.05
0.55	4.12	5.49	6.87	1.30	19.96	24.95	2.05	49.41
0.56	4.23	5.64	7.05	1.31	20.15	25.24	2.06	49.78
0.57	4.35	5.80	7.24	1.32	20.42	25.53	2.07	50.14
0.58	4.46	5.95	7.44	1.33	20.66	25.82	2.08	50.50
0.59	4.58	6.10	7.63	1.34	20.89	26.11	2.09	50.87
0.60	4.69	6.26	7.82	1.35	21.12	26.41	2.10	51.22

TABLE 2—(Concluded)

DISCHARGE OF CIPOLLETTI WEIRS 3 TO 5 FEET LONG IN CUBIC FEET PER SECOND, COMPUTED FROM FORMULA $Q = 3.367 L H^3$

Head H, feet	Length of weir L, feet		Head H, feet	Length of weir L, feet		Head H, feet	Length of weir L, feet	
	3.0	4.0		3.0	4.0		3.0	4.0
0.61	4.81	6.42	1.36	21.36	26.70	2.11	51.60
0.62	4.93	6.57	1.37	21.60	27.00	2.12	51.97
0.63	5.05	6.73	1.38	21.83	27.29	2.13	52.34
0.64	5.17	6.90	1.39	22.07	27.59	2.14	52.70
0.65	5.29	7.06	1.40	22.31	27.89	2.15	53.07
0.66	5.42	7.22	1.41	22.55	28.19	2.16	53.44
0.67	5.54	7.38	1.42	22.79	28.49	2.17	53.82
0.68	5.66	7.55	1.43	23.03	28.79	2.18	54.18
0.69	5.79	7.72	1.44	23.27	29.09	2.19	54.56
0.70	5.92	7.89	1.45	23.52	29.40	2.20	54.93
0.71	6.04	8.06	1.46	23.76	29.70	2.21	55.31
0.72	6.17	8.23	1.47	24.00	30.00	2.22	55.69
0.73	6.30	8.40	1.48	24.25	30.31	2.23	56.06
0.74	6.43	8.57	1.49	24.50	30.62	2.24	56.44
0.75	6.56	8.75	1.50	24.70	30.93	2.25	56.82

Bill of Material for Cipolletti Weir Box

The bill of material given below covers what is necessary for an 18-inch Cipolletti weir box and weir as installed at Davis. This box is long enough and of such other dimensions as to meet the general conditions that have been named. In some situations the box might be made somewhat shorter, but the additional cost required for a 12-foot over, say, an 8-foot box is not sufficient to justify using the shorter box where only a small number of weirs are involved. This box is suitable for measuring from about 0.25 to about 1.75 or 2 cubic feet per second, equivalent to 12½ to 100 customary California miner's inches.

Bill of Material for Cipolletti Weir Box

	Board feet
4 pc. 1" × 12" × 2' (cut-off walls)	8
1 pc. 1" × 12" × 7' (cut-off walls)	7
4 pc. 1" × 12" × 12' (main walls)	48
7 pc. 1" × 12" × 12' (floor)	84
8 pc. 2" × 4" × 3' (posts)	16
2 pc. 4" × 4" × 4'-4" (posts)	12
8 pc. 1" × 2" × 2' (cleats)	3
1 pc. 2" × 4" × 4'-6" (gate stem)	3
1 pc. 2" × 2" × 6' (gate stem brace)	2
2 pc. 2" × 12" × 3' (gate)	12
2 pc. 2" × 12" × 3' (weir board)	12
8 pc. 2" × 4" × 3'-10" (caps and sills)	21
Total	228

WEIR WITHOUT END CONTRACTIONS

This is illustrated by Figure 14, which is from a photograph of the weir of this type installed at Davis. It is different from the Cipolletti weir just described mainly in having the weir board extend the full width of the weir box. The same bill of material can therefore be used except that more or less lumber will be necessary according to the width and height of the weir chosen. This type of weir can only be used in a channel of constant cross-section and vertical sides directly

above the weir, such as is provided in the box shown. This weir must be so constructed as to allow free access of air to the under side of the falling sheet of water. This can be accomplished by making a horizontal notch in the side of the weir box directly below the crest and extending down stream to the end of the wall. The water must not be allowed to approach the weir with an appreciable velocity. The velocity of approach is largely governed by the height of the weir board above the bottom of the box. It has been suggested by Professor Richard R. Lyman,* of the University of Utah,† that a weir of this type 1 foot or less long should be 6 inches high, that with lengths of 1.5 to 2.5 feet, it should be 9 inches high, that with lengths of 3 to 4 feet it should be 1 foot high, and that with lengths of 5 to 7 feet it should be 1.5 feet high. In the same bulletin Professor Lyman gives the following table of discharges per foot of length for such a weir.†

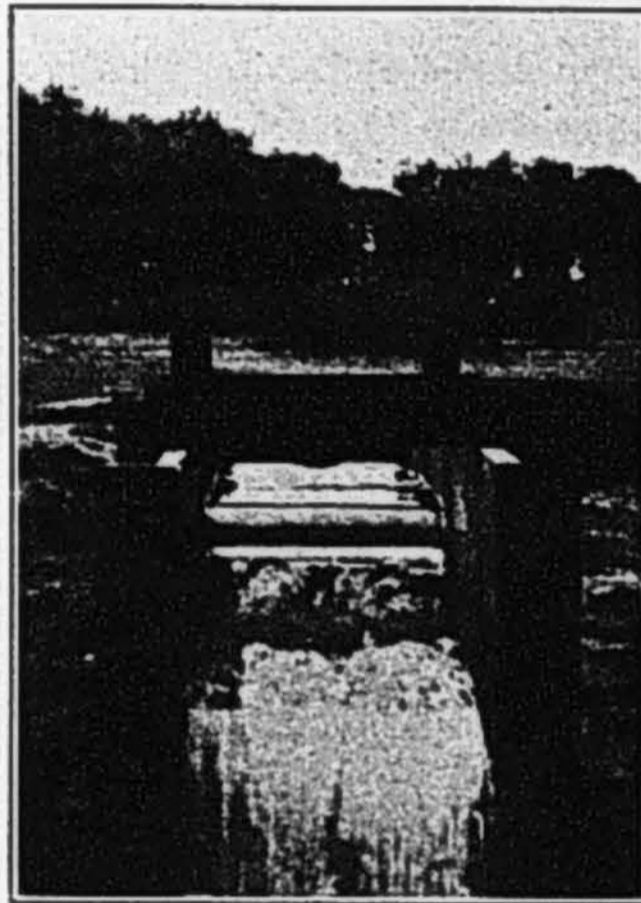

Fig. 14.—Photograph of weir without end contractions

above the weir, such as is provided in the box shown. This weir must be so constructed as to allow free access of air to the under side of the falling sheet of water. This can be accomplished by making a horizontal notch in the side of the weir box directly below the crest and extending down stream to the end of the wall. The water must not be allowed to approach the weir with an appreciable velocity. The velocity of approach is largely governed by the height of the weir board above the bottom of the box. It has been suggested by Professor Richard R. Lyman,* of the University of Utah,† that a weir of this type 1 foot or less long should be 6 inches high, that with lengths of 1.5 to 2.5 feet, it should be 9 inches high, that with lengths of 3 to 4 feet it should be 1 foot high, and that with lengths of 5 to 7 feet it should be 1.5 feet high. In the same bulletin Professor Lyman gives the following table of discharges per foot of length for such a weir.†

TABLE 3

DISCHARGE OF WEIRS WITHOUT END CONTRACTIONS IN CUBIC FEET PER SECOND

Head in inches	Head in feet	Weir 0.5 ft. high	Weir 0.75 ft. high	Weir 1.00 ft. high	Weir 1.50 ft. high
2 3/8	0.200	0.315	0.314	0.313	0.312
2 7/16	0.205	0.327	0.326	0.325	0.324
2 1/2	0.210	0.340	0.337	0.336	0.335
2 9/16	0.215	0.352	0.351	0.350	0.348
2 5/8	0.220	0.365	0.363	0.360	0.359
2 11/16	0.225	0.377	0.375	0.372	0.370
2 3/4	0.230	0.392	0.388	0.385	0.383
2 13/16	0.235	0.404	0.400	0.398	0.396
2 7/8	0.240	0.420	0.415	0.412	0.408
2 15/16	0.245	0.433	0.427	0.425	0.422

* Utah Engineering Experiment Station, Bull. 5.

† The tables given in the bulletin referred to cover depths for weirs up to 6 feet high.

TABLE 3—(Continued)

DISCHARGE OF WEIRS WITHOUT END CONTRACTIONS IN CUBIC FEET PER SECOND

Head in inches	Head in feet	Weir 0.5 ft. high	Weir 0.75 ft. high	Weir 1.00 ft. high	Weir 1.50 ft. high
3	0.250	0.446	0.442	0.438	0.435
3 1/16	0.255	0.460	0.453	0.450	0.447
3 1/8	0.260	0.475	0.468	0.465	0.460
3 3/16	0.265	0.490	0.483	0.478	0.475
3 1/4	0.270	0.503	0.497	0.493	0.488
3 5/16	0.275	0.515	0.508	0.505	0.501
3 3/8	0.280	0.530	0.524	0.518	0.514
3 7/16	0.285	0.546	0.537	0.532	0.526
3 1/2	0.290	0.560	0.552	0.547	0.544
3 9/16	0.295	0.576	0.566	0.560	0.555
3 5/8	0.300	0.595	0.584	0.576	0.570
3 3/4	0.305	0.610	0.595	0.588	0.582
3 11/16	0.310	0.625	0.612	0.605	0.599
3 7/8	0.315	0.640	0.627	0.620	0.613
3 13/16	0.320	0.655	0.645	0.636	0.630
3 7/8	0.325	0.670	0.655	0.650	0.641
3 15/16	0.330	0.690	0.672	0.665	0.656
4	0.335	0.705	0.690	0.680	0.670
4 1/16	0.340	0.720	0.705	0.697	0.688
4 1/8	0.345	0.738	0.720	0.710	0.703
4 3/16	0.350	0.755	0.735	0.726	0.717
4 1/4	0.355	0.770	0.752	0.743	0.732
4 5/16	0.360	0.790	0.772	0.760	0.750
4 3/8	0.365	0.805	0.786	0.775	0.764
4 7/16	0.370	0.824	0.802	0.792	0.780
4 1/2	0.375	0.840	0.817	0.805	0.795
4 9/16	0.380	0.860	0.836	0.825	0.813
4 5/8	0.385	0.875	0.853	0.840	0.826
4 11/16	0.390	0.896	0.870	0.857	0.845
4 3/4	0.395	0.910	0.885	0.870	0.860
4 13/16	0.400	0.930	0.905	0.893	0.875
4 7/8	0.405	0.950	0.922	0.910	0.895
4 15/16	0.410	0.970	0.940	0.925	0.910
5	0.415	0.990	0.956	0.943	0.925
5 1/16	0.420	1.005	0.975	0.958	0.943
5 1/8	0.425	1.020	0.995	0.977	0.963
5 1/4	0.430	1.045	1.010	0.996	0.980
5 3/16	0.435	1.065	1.030	1.010	0.996
5 1/2	0.440	1.083	1.045	1.026	1.010
5 5/16	0.445	1.100	1.063	1.045	1.026

TABLE 3—(Continued)

DISCHARGE OF WEIRS WITHOUT END CONTRACTIONS IN CUBIC FEET PER SECOND

Head in inches	Head in feet	Weir 0.5 ft. high	Weir 0.75 ft. high	Weir 1.00 ft. high	Weir 1.50 ft. high
5 $\frac{3}{8}$	0.450	1.120	1.080	1.060	1.040
5 $\frac{7}{16}$	0.455	1.140	1.100	1.080	1.057
5 $\frac{1}{2}$	0.460	1.164	1.125	1.105	1.085
5 $\frac{9}{16}$	0.465	1.185	1.140	1.120	1.100
5 $\frac{5}{8}$	0.470	1.205	1.163	1.143	1.120
5 $\frac{11}{16}$	0.475	1.230	1.185	1.162	1.140
5 $\frac{3}{4}$	0.480	1.250	1.205	1.185	1.160
5 $\frac{13}{16}$	0.485	1.270	1.223	1.200	1.175
5 $\frac{7}{8}$	0.490	1.290	1.245	1.220	1.200
5 $\frac{15}{16}$	0.495	1.310	1.265	1.233	1.215
6	0.500	1.335	1.285	1.263	1.235
6 $\frac{1}{16}$	0.505	1.355	1.300	1.280	1.250
6 $\frac{1}{8}$	0.510	1.370	1.320	1.296	1.270
6 $\frac{3}{16}$	0.515	1.390	1.340	1.317	1.287
6 $\frac{1}{4}$	0.520	1.415	1.360	1.335	1.305
6 $\frac{5}{16}$	0.525	1.440	1.380	1.355	1.325
6 $\frac{3}{8}$	0.530	1.465	1.405	1.375	1.346
6 $\frac{7}{16}$	0.535	1.490	1.425	1.400	1.365
6 $\frac{1}{2}$	0.540	1.510	1.440	1.415	1.385
6 $\frac{9}{16}$	0.545	1.530	1.465	1.435	1.403
6 $\frac{5}{8}$	0.550	1.555	1.490	1.460	1.425
6 $\frac{11}{16}$	0.555	1.575	1.505	1.475	1.440
6 $\frac{3}{4}$	0.560	1.595	1.525	1.495	1.460
6 $\frac{7}{8}$	0.565	1.616	1.545	1.515	1.475
6 $\frac{15}{16}$	0.570	1.640	1.570	1.535	1.500
6 $\frac{3}{4}$	0.575	1.665	1.590	1.555	1.517
6 $\frac{15}{16}$	0.580	1.686	1.610	1.576	1.537
7	0.585	1.713	1.635	1.605	1.565
7 $\frac{1}{16}$	0.590	1.740	1.670	1.630	1.590
7 $\frac{1}{8}$	0.595	1.760	1.685	1.650	1.605
7 $\frac{3}{16}$	0.600	1.790	1.700	1.675	1.625
7 $\frac{1}{4}$	0.605	1.805	1.730	1.695	1.655
7 $\frac{5}{16}$	0.610	1.830	1.750	1.715	1.675
7 $\frac{3}{8}$	0.615	1.855	1.755	1.735	1.695
7 $\frac{7}{16}$	0.620	1.880	1.795	1.760	1.710
7 $\frac{1}{2}$	0.625	1.905	1.815	1.780	1.730
7 $\frac{9}{16}$	0.630	1.930	1.845	1.805	1.760
7 $\frac{5}{8}$	0.635	1.955	1.875	1.835	1.785
7 $\frac{11}{16}$	0.640	1.980	1.900	1.860	1.815
7 $\frac{3}{4}$	0.645	2.010	1.915	1.870	1.820

TABLE 3—(Continued)

DISCHARGE OF WEIRS WITHOUT END CONTRACTIONS IN CUBIC FEET PER SECOND

Head in inches	Head in feet	Weir 0.5 ft. high	Weir 0.75 ft. high	Weir 1.00 ft. high	Weir 1.50 ft. high
7 $\frac{13}{16}$	0.650	2.035	1.930	1.890	1.840
7 $\frac{7}{8}$	0.655	2.060	1.960	1.915	1.860
7 $\frac{15}{16}$	0.660	2.085	1.985	1.945	1.890
8	0.665	2.110	2.005	1.965	1.910
8 $\frac{1}{16}$	0.670	2.135	2.025	1.980	1.930
8 $\frac{1}{8}$	0.675	2.160	2.055	2.000	1.945
8 $\frac{3}{16}$	0.680	2.185	2.075	2.030	1.980
8 $\frac{5}{16}$	0.685	2.210	2.095	2.050	1.990
8 $\frac{1}{4}$	0.690	2.240	2.125	2.075	2.025
8 $\frac{3}{8}$	0.695	2.260	2.150	2.095	2.040
8 $\frac{5}{8}$	0.700	2.295	2.180	2.130	2.070
8 $\frac{7}{16}$	0.705	2.325	2.200	2.155	2.100
8 $\frac{1}{2}$	0.710	2.350	2.220	2.170	2.115
8 $\frac{9}{16}$	0.715	2.380	2.250	2.195	2.140
8 $\frac{3}{4}$	0.720	2.410	2.275	2.220	2.160
8 $\frac{11}{16}$	0.725	2.435	2.300	2.245	2.180
8 $\frac{3}{4}$	0.730	2.465	2.325	2.270	2.200
8 $\frac{13}{16}$	0.735	2.490	2.350	2.295	2.230
8 $\frac{7}{8}$	0.740	2.520	2.375	2.320	2.250
8 $\frac{15}{16}$	0.745	2.550	2.405	2.340	2.275
9	0.750	2.585	2.430	2.375	2.300
9 $\frac{1}{16}$	0.755	2.605	2.455	2.400	2.325
9 $\frac{1}{8}$	0.760	2.640	2.480	2.415	2.340
9 $\frac{3}{16}$	0.765	2.670	2.510	2.440	2.370
9 $\frac{1}{4}$	0.770	2.700	2.540	2.470	2.400
9 $\frac{5}{16}$	0.775	2.730	2.560	2.500	2.420
9 $\frac{3}{8}$	0.780	2.760	2.590	2.515	2.440
9 $\frac{7}{16}$	0.785	2.790	2.610	2.550	2.460
9 $\frac{1}{2}$	0.790	2.820	2.630	2.570	2.480
9 $\frac{9}{16}$	0.795	2.850	2.660	2.595	2.510
9 $\frac{5}{8}$	0.800	2.890	2.700	2.625	2.550
9 $\frac{11}{16}$	0.805	2.910	2.730	2.660	2.575
9 $\frac{3}{4}$	0.810	2.940	2.755	2.680	2.595
9 $\frac{13}{16}$	0.815	2.975	2.780	2.700	2.610
9 $\frac{7}{8}$	0.820	3.010	2.810	2.735	2.640
9 $\frac{15}{16}$	0.825	3.045	2.840	2.770	2.670
10	0.830	3.070	2.870	2.790	2.700
10 $\frac{1}{16}$	0.835	3.100	2.905	2.830	2.730
10 $\frac{1}{8}$	0.840	3.130	2.930	2.840	2.760
10 $\frac{3}{16}$	0.845	3.160	2.950	2.880	2.785

TABLE 3—(Continued)

DISCHARGE OF WEIRS WITHOUT END CONTRACTIONS IN CUBIC FEET PER SECOND

Head in inches	Head in feet	Weir 0.5 ft. high	Weir 0.75 ft. high	Weir 1.00 ft. high	Weir 1.50 ft. high
10 $\frac{3}{16}$	0.850	3.190	2.990	2.910	2.800
10 $\frac{1}{4}$	0.855	3.230	3.015	2.930	2.840
10 $\frac{5}{16}$	0.860	3.260	3.040	2.960	2.860
10 $\frac{3}{8}$	0.865	3.290	3.070	2.980	2.880
10 $\frac{7}{16}$	0.870	3.320	3.100	3.010	2.910
10 $\frac{1}{2}$	0.875	3.350	3.120	3.035	2.930
10 $\frac{9}{16}$	0.880	3.395	3.160	3.070	2.965
10 $\frac{5}{8}$	0.885	3.415	3.180	3.090	2.980
10 $\frac{11}{16}$	0.890	3.445	3.200	3.120	3.010
10 $\frac{3}{4}$	0.895	3.480	3.235	3.150	3.040
10 $\frac{13}{16}$	0.900	3.520	3.270	3.180	3.070
10 $\frac{7}{8}$	0.905	3.550	3.300	3.210	3.100
10 $\frac{15}{16}$	0.910	3.580	3.330	3.235	3.120
11	0.915	3.620	3.360	3.260	3.155
11 $\frac{1}{16}$	0.920	3.655	3.390	3.290	3.180
11 $\frac{1}{8}$	0.925	3.690	3.420	3.325	3.210
11 $\frac{3}{8}$	0.930	3.720	3.445	3.350	3.230
11 $\frac{5}{16}$	0.935	3.760	3.480	3.380	3.250
11 $\frac{3}{4}$	0.940	3.800	3.510	3.405	3.290
11 $\frac{7}{16}$	0.945	3.830	3.540	3.430	3.315
11 $\frac{5}{8}$	0.950	3.870	3.580	3.470	3.350
11 $\frac{9}{16}$	0.955	3.900	3.610	3.500	3.380
11 $\frac{1}{2}$	0.960	3.940	3.640	3.540	3.400
11 $\frac{13}{16}$	0.965	3.980	3.680	3.570	3.430
11 $\frac{3}{4}$	0.970	4.010	3.700	3.590	3.450
11 $\frac{5}{8}$	0.975	4.040	3.740	3.625	3.490
11 $\frac{7}{8}$	0.980	4.080	3.770	3.650	3.520
11 $\frac{9}{16}$	0.985	4.120	3.800	3.690	3.555
11 $\frac{11}{16}$	0.990	4.150	3.830	3.710	3.580
11 $\frac{13}{16}$	0.995	4.180	3.850	3.730	3.590
12	1.000	4.230	3.900	3.780	3.640
12 $\frac{1}{8}$	1.010	4.300	3.970	3.840	3.710
12 $\frac{1}{4}$	1.020	4.380	4.030	3.900	3.760
12 $\frac{3}{8}$	1.030	4.450	4.100	3.970	3.820
12 $\frac{1}{2}$	1.040	4.520	4.170	4.040	3.880
12 $\frac{3}{4}$	1.050	4.610	4.240	4.120	3.950
12 $\frac{5}{8}$	1.060	4.800	4.320	4.180	4.020
12 $\frac{7}{16}$	1.070	4.760	4.370	4.220	4.070
12 $\frac{9}{16}$	1.080	4.820	4.430	4.280	4.130
12 $\frac{11}{16}$	1.090	4.900	4.480	4.340	4.180

TABLE 3—(Continued)

DISCHARGE OF WEIRS WITHOUT END CONTRACTIONS IN CUBIC FEET PER SECOND

Head in inches	Head in feet	Weir 0.5 ft. high	Weir 0.75 ft. high	Weir 1.00 ft. high	Weir 1.50 ft. high
13 $\frac{3}{16}$	1.100	4.980	4.570	4.420	4.240
13 $\frac{1}{2}$	1.110	5.060	4.640	4.480	4.320
13 $\frac{5}{16}$	1.120	5.150	4.710	4.560	4.370
13 $\frac{3}{8}$	1.130	5.220	4.780	4.610	4.420
13 $\frac{7}{16}$	1.140	5.300	4.840	4.670	4.480
13 $\frac{9}{16}$	1.150	5.380	4.910	4.740	4.560
13 $\frac{11}{16}$	1.160	5.450	4.980	4.800	4.610
14 $\frac{1}{16}$	1.170	5.510	5.050	4.870	4.670
14 $\frac{1}{8}$	1.180	5.600	5.130	4.950	4.740
14 $\frac{1}{4}$	1.190	5.680	5.200	5.000	4.800
14 $\frac{3}{8}$	1.200	5.780	5.250	5.075	4.870
14 $\frac{1}{2}$	1.210	5.860	5.340	5.150	4.940
14 $\frac{5}{8}$	1.220	5.940	5.420	5.250	5.000
14 $\frac{3}{4}$	1.230	6.000	5.460	5.270	5.050
14 $\frac{7}{8}$	1.240	6.100	5.550	5.360	5.150
15	1.250	6.200	5.620	5.430	5.220
15 $\frac{1}{8}$	1.260	6.275	5.675	5.500	5.275
15 $\frac{1}{4}$	1.270	5.750	5.560	5.325
15 $\frac{3}{8}$	1.280	5.820	5.620	5.380
15 $\frac{1}{2}$	1.290	5.900	5.680	5.450
15 $\frac{3}{4}$	1.300	5.975	5.775	5.525
15 $\frac{5}{8}$	1.310	6.060	5.850	5.600
15 $\frac{7}{16}$	1.320	6.150	5.920	5.675
15 $\frac{9}{16}$	1.330	6.200	6.000	5.730
16 $\frac{1}{16}$	1.340	6.300	6.050	5.800
16 $\frac{1}{8}$	1.350	6.375	6.130	5.875
16 $\frac{1}{4}$	1.360	6.450	6.200	5.940
16 $\frac{3}{8}$	1.370	6.505	6.300	6.000
16 $\frac{1}{2}$	1.380	6.625	6.375	6.080
16 $\frac{3}{4}$	1.390	6.700	6.459	6.150
16 $\frac{5}{8}$	1.400	6.780	6.530	6.230
16 $\frac{7}{16}$	1.410	6.860	6.620	6.320
17 $\frac{1}{16}$	1.420	6.950	6.675	6.375
17 $\frac{1}{8}$	1.430	7.000	6.750	6.450
17 $\frac{1}{4}$	1.440	7.075	6.820	6.520
17 $\frac{3}{8}$	1.450	7.150	6.900	6.600
17 $\frac{1}{2}$	1.460	7.250	6.975	6.660
17 $\frac{5}{8}$	1.470	7.330	7.050	6.740
17 $\frac{3}{4}$	1.480	7.400	7.130	6.800
17 $\frac{7}{8}$	1.490	7.480	7.200	6.850

TABLE 3—(Concluded)

DISCHARGE OF WEIRS WITHOUT END CONTRACTIONS IN CUBIC FEET PER SECOND

Head in inches	Head in feet	Weir 0.5 ft. high	Weir 0.75 ft. high	Weir 1.00 ft. high	Weir 1.50 ft. high
18	1.500	7.600	7.300	6.950
18 $\frac{1}{8}$	1.510	7.660	7.360	7.020
18 $\frac{1}{4}$	1.520	7.750	7.450	7.100
18 $\frac{3}{8}$	1.530	7.825	7.520	7.160
18 $\frac{1}{2}$	1.540	7.900	7.600	7.230
18 $\frac{5}{8}$	1.550	7.980	7.660	7.300
18 $\frac{3}{4}$	1.560	8.075	7.730	7.400
18 $\frac{7}{8}$	1.570	8.150	7.820	7.450
18 $\frac{9}{16}$	1.580	8.250	7.900	7.525
19 $\frac{1}{16}$	1.590	8.300	7.960	7.560

SUBMERGED ORIFICES

The measurement of water through orifices has long been common in irrigation practice and various forms of orifices have been developed. The essential condition in the use of an orifice, eliminating the question of form, is that the water on the up-stream side of the orifice shall completely submerge it. If, when in use, the surface of the water on the lower side of the orifice is below the bottom thereof, the orifice is said to have a free discharge. If the surface of the water on the lower side of the orifice is above the top of the orifice, completely submerging it, it is classed as a submerged orifice. Except in the case of the miner's inch box, which is really but a form of orifice with free discharge, use of the orifice in irrigation practice is confined to the submerged form.

Submerged orifices as used can be divided into two general types, viz: those with orifices of fixed dimensions (Figs. 15 and 16) and those built so that the height of the opening may be varied (Figs. 17 and 18). Orifices with fixed dimensions are usually made with sharp edges similar to the crest of a weir. The most usual type of the second class is the simple head gate (Figs. 17 and 18), which is also used as a submerged orifice, the height of opening and loss of head being adjusted to the amount which it is desired to turn out and to the loss of head available. Of these two types, the sharp-edged orifice with fixed dimensions is much the more accurate.

SUBMERGED ORIFICES WITH FIXED DIMENSIONS

This type of submerged orifice is used for measurement only, the fixing of the size of the opening preventing its use as a headgate. The experiments which have been made by hydraulic engineers to determine the coefficient of discharge for the standard sharp-edged orifice

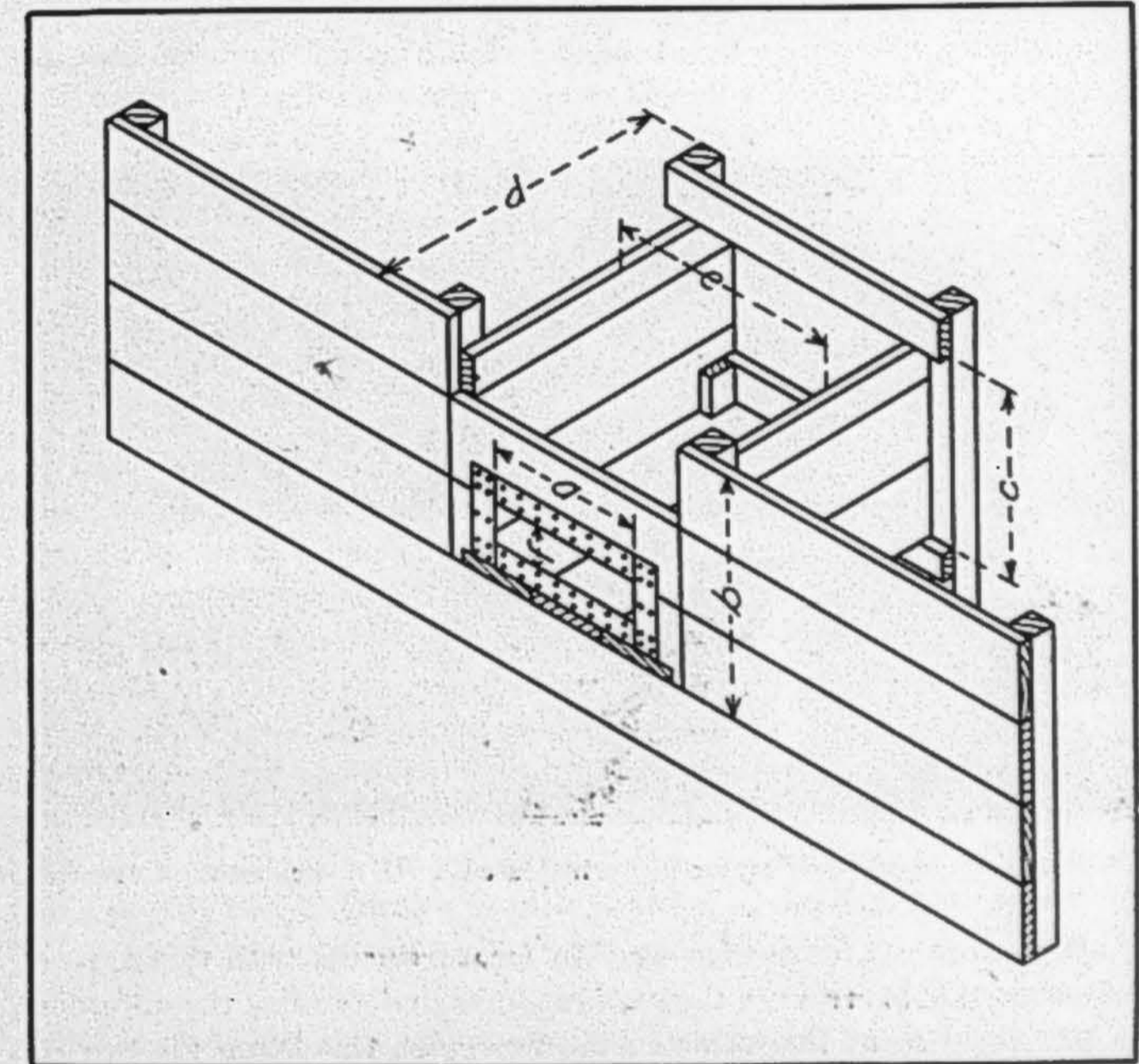

Fig. 15.—Drawing of submerged orifice used by U. S. Reclamation Service

approach in accuracy and number those that have been made for sharp-edged weirs. These experiments have shown the coefficients to vary slightly with the size of the orifice. For the sizes used in the measurement of individual deliveries of irrigation water this variation may be overlooked and one formula used for all sizes.

In order that the known formula for the discharge through such orifices shall apply, certain standard conditions must be observed in the construction and use of these orifices. The edges of the orifice must

be sharp and definite in shape. It is preferable to use a thin metal plate as this is not subject to wear and change. The edges of the orifice should not be too near to the sides of the box on either the upper or lower sides; a distance equal to twice the least dimension of the orifice is sufficient. The orifice should be vertical with the top and bottom edges level. The ditch above the orifice should be sufficiently large so that the velocity of approach will be small, as is necessary in the case of a weir. Corrections can be made in the computations for any velocity of approach but such corrections are more or less uncertain.

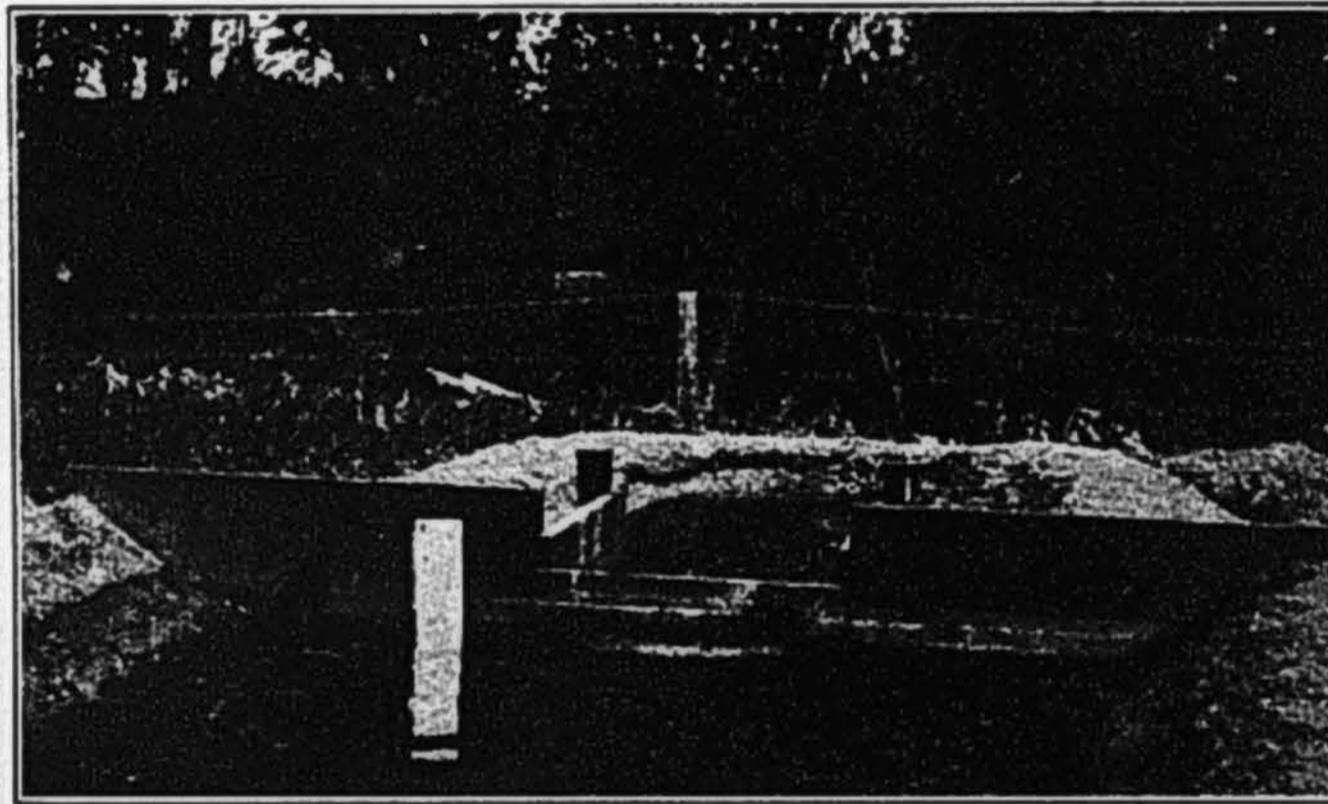

Fig. 16.—Photograph of submerged orifice used by U. S. Reclamation Service

The principal sources of error in measurements with this type of orifice are due to errors in the gage readings to determine the difference in the elevation of the water on the two sides, this being the head or pressure that forces the water through the orifice. As these orifices are generally used where there is but little loss of head available, the opening is usually made sufficiently large to require as little loss of head as is practicable. Any error in reading this loss of head is thus a larger percentage of the whole than it would be for greater total differences.

In the use of the submerged orifice two gage readings are required, one above and one below the orifice. The reading above the orifice should be taken back from the edge of the orifice. In the type of structure shown in figures 13 and 14 this can be taken on the side wing wall.

The measurement below the orifice should be taken at least 2 feet below it and farther if the discharging water is rough. A convenient method of obtaining the difference in the elevation of the water above and below the orifice is to set marks at equal elevations above and below the orifice or to set a board with its top level extending above and below the orifice sufficiently far to give good points for measurements. The difference in measurements from this level board to the surface of the water above and below the orifice gives the head or pressure under which the water is passing through the orifice.

The type of orifice described above and illustrated in figures 13 and 14 has been adopted by the U. S. Reclamation Service for use where sufficient loss of head is not available for weirs. The data given below regarding the sizes of the structures, and the table of discharges (Table 4) are taken from the publication of the Reclamation Service on the measurement of irrigation water and from their standard plans for submerged orifices. The cost of one of these devices installed will vary from about \$5 to about \$15.

DIMENSIONS AND LUMBER FOR STANDARD SIZES OF SUBMERGED RECTANGULAR ORIFICES ADOPTED BY U. S. RECLAMATION SERVICE

Height in ft. f	Size of Orifice		Headwall height in ft. b	Side height in ft. c	Structure length in ft. d	Floor width in ft. e	Approximate quantity of lumber in ft. B.M.
	Length in ft. a	Area in sq. ft.					
0.25	1.00	0.25	3.0	2.5	4.0	2.0	150
	2.00	0.50	3.0	2.5	4.0	3.0	170
	3.00	0.75	3.0	2.5	4.0	4.0	185
0.50	1.00	0.50	3.0	2.5	4.0	2.0	150
	1.50	0.75	3.0	2.5	4.0	2.5	160
	2.00	1.00	3.0	2.5	4.0	3.0	170
	2.50	1.25	3.0	2.5	4.0	3.5	175
	3.00	1.50	3.5	2.5	4.0	4.0	210
0.75	1.33	1.00	3.0	2.5	4.0	2.0	150
	1.67	1.25	3.0	2.5	4.0	2.5	160
	2.00	1.50	3.0	2.5	4.0	3.0	170
	2.33	1.75	3.5	3.0	4.0	3.0	190
	2.67	2.00	3.5	3.0	4.0	3.5	200

TABLE 4

DISCHARGE OF SUBMERGED RECTANGULAR ORIFICES IN CUBIC FEET PER SECOND,
 COMPUTED FROM THE FORMULA $Q = 0.61 \sqrt{2gH} A$ —TAKEN FROM
 "MEASUREMENT OF IRRIGATION WATER" TABLES OF
 U. S. RECLAMATION SERVICE

Head H, feet	Cross-sectional area A of orifice, square feet							
	0.25	0.5	0.75	1.0	1.25	1.5	1.75	2.00
0.01	0.122	0.245	0.367	0.489	0.611	0.734	0.856	0.978
.02	.173	.346	.518	.691	.864	1.037	1.210	1.382
.03	.212	.424	.635	.847	1.059	1.271	1.483	1.694
.04	.245	.489	.734	.978	1.223	1.468	1.712	1.957
.05	.273	.547	.820	1.093	1.367	1.640	1.913	2.186
.06	.300	.599	.899	1.198	1.497	1.797	2.097	2.396
.07	.324	.647	.971	1.294	1.617	1.941	2.265	2.588
.08	.346	.691	1.037	1.383	1.729	2.074	2.420	2.706
.09	.367	.734	1.101	1.468	1.835	2.201	2.638	2.935
.10	.387	.773	1.160	1.557	1.933	2.320	2.707	3.094
.11	.406	.811	1.217	1.622	2.027	2.433	2.839	3.244
.12	.424	.847	1.271	1.694	2.118	2.542	2.965	3.389
.13	.441	.882	1.323	1.764	2.205	2.645	3.086	3.527
.14	.458	.915	1.373	1.830	2.287	2.745	3.203	3.660
.15	.474	.947	1.421	1.895	2.369	2.842	3.316	3.790
.16	.489	.978	1.467	1.956	2.445	2.934	3.423	3.912
.17	.504	1.008	1.512	2.016	2.520	3.024	3.528	4.032
.18	.519	1.037	1.556	2.075	2.593	3.112	3.631	4.150
.19	.533	1.066	1.599	2.132	2.665	3.198	3.731	4.264
.20	.547	1.094	1.641	2.188	2.735	3.282	3.829	4.376
.21	.561	1.120	1.681	2.241	2.801	3.361	3.921	4.482
.22	.574	1.148	1.722	2.296	2.870	3.464	4.018	4.592
.23	.587	1.172	1.759	2.345	2.931	3.517	4.103	4.690
.24	.600	1.198	1.797	2.396	2.995	3.599	4.193	4.792
.25	.612	1.223	1.834	2.446	3.057	3.668	4.280	4.891
.26	.624	1.247	1.871	2.494	3.117	3.741	4.365	4.988
.27	.636	1.270	1.906	2.541	3.176	3.811	4.446	5.082
.28	.646	1.294	1.942	2.589	3.236	3.883	4.530	5.178
.29	.659	1.319	1.978	2.638	3.297	3.956	4.616	5.276
.30	.670	1.339	2.009	2.678	3.347	4.017	4.687	5.356
.31	.681	1.363	2.045	2.726	3.407	4.089	4.771	5.452
.32	.692	1.382	2.073	2.764	3.455	4.146	4.837	5.528
.33	.703	1.405	2.107	2.810	3.513	4.215	4.917	5.620
.34	.713	1.426	2.139	2.852	3.565	4.278	4.991	5.704
.35	.724	1.446	2.169	2.892	3.615	4.338	5.061	5.784

TABLE 4—(Continued)

DISCHARGE OF SUBMERGED RECTANGULAR ORIFICES IN CUBIC FEET PER SECOND,
 COMPUTED FROM THE FORMULA $Q = 0.61 \sqrt{2gH} A$ —TAKEN FROM
 "MEASUREMENT OF IRRIGATION WATER" TABLES OF
 U. S. RECLAMATION SERVICE

Head H, feet	Cross-sectional area A of orifice, square feet							
	0.25	0.5	0.75	1.0	1.25	1.5	1.75	2.00
.36	.734	1.467	2.201	2.934	3.667	4.401	5.135	5.868
.37	.745	1.488	2.232	2.976	3.720	4.464	5.208	5.952
.38	.754	1.508	2.262	3.016	3.770	4.524	5.278	6.032
.39	.764	1.527	2.291	3.054	3.818	4.582	5.345	6.109
.40	.774	1.547	2.321	3.094	3.867	4.641	5.415	6.188
.41	.783	1.567	2.350	3.133	3.917	4.700	5.483	6.266
.42	.792	1.585	2.377	3.170	3.962	4.754	5.547	6.339
.43	.802	1.604	2.406	3.208	4.010	4.812	5.614	6.416
.44	.811	1.622	2.433	3.244	4.055	4.866	5.677	6.488
.45	.820	1.640	2.461	3.281	4.101	4.921	5.741	6.562
.46	.829	1.659	2.489	3.318	4.147	4.977	5.807	6.636
.47	.839	1.678	2.517	3.356	4.195	5.035	5.874	6.713
.48	.847	1.695	2.542	3.389	4.237	5.084	5.931	6.778
.49	.856	1.712	2.568	3.424	4.280	5.136	5.992	6.848
.50	.865	1.729	2.594	3.458	4.323	5.188	6.052	6.917
.51	.873	1.746	2.620	3.493	4.366	5.239	6.112	6.986
.52	.882	1.763	2.645	3.527	4.409	5.290	6.172	7.054
.53	.890	1.780	2.670	3.560	4.451	5.341	6.231	7.121
.54	.898	1.797	2.695	3.593	4.491	5.390	6.288	7.186
.55	.907	1.813	2.719	3.626	4.533	5.439	6.345	7.252
.56	.915	1.830	2.745	3.660	4.575	5.490	6.405	7.320
.57	.923	1.846	2.769	3.692	4.615	5.538	6.461	7.384
.58	.931	1.862	2.794	3.725	4.656	5.587	6.518	7.450
.59	.939	1.879	2.818	3.757	4.697	5.636	6.575	7.514
.60	.947	1.895	2.842	3.790	4.737	5.684	6.632	7.579
.61	.955	1.910	2.865	3.820	4.775	5.730	6.685	7.640
.62	.963	1.925	2.887	3.850	4.812	5.775	6.737	7.700
.63	.971	1.941	2.911	3.882	4.853	5.823	6.793	7.764
.64	.978	1.956	2.934	3.912	4.890	5.868	6.846	7.824
.65	.986	1.972	2.958	3.944	4.930	5.916	6.902	7.888
.66	.993	1.987	2.980	3.974	4.967	5.960	6.954	7.947
.67	1.001	2.002	3.003	4.004	5.005	6.006	7.007	8.008
.68	1.008	2.016	3.024	4.032	5.040	6.048	7.056	8.064
.69	1.016	2.032	3.048	4.064	5.080	6.096	7.112	8.128
.70	1.023	2.046	3.069	4.092	5.115	6.138	7.161	8.184

TABLE 4—(Concluded)

DISCHARGE OF SUBMERGED RECTANGULAR ORIFICES IN CUBIC FEET PER SECOND, COMPUTED FROM THE FORMULA $Q=0.61 \sqrt{2g}HA$ —TAKEN FROM "MEASUREMENT OF IRRIGATION WATER" TABLES OF U. S. RECLAMATION SERVICE

Head H, feet	Cross-sectional area A of orifice, square feet							
	0.25	0.5	0.75	1.0	1.25	1.5	1.75	2.00
.71	1.031	2.062	3.093	4.124	5.155	6.186	7.217	8.248
.72	1.038	2.076	3.114	4.152	5.190	6.228	7.266	8.304
.73	1.045	2.090	3.135	4.180	5.225	6.270	7.315	8.360
.74	1.052	2.104	3.158	4.210	5.260	6.311	7.369	8.421
.75	1.059	2.118	3.178	4.237	5.296	6.355	7.413	8.475
.76	1.066	2.132	3.198	4.264	5.330	6.396	7.462	8.528
.77	1.072	2.145	3.217	4.290	5.362	6.434	7.507	8.579
.78	1.080	2.160	3.240	4.320	5.400	6.480	7.560	8.640
.79	1.087	2.174	3.261	4.348	5.435	6.522	7.609	8.696
.80	1.094	2.188	3.282	4.376	5.470	6.564	7.658	8.752

TABLE 5

COEFFICIENT C TO BE APPLIED TO A DISCHARGE GIVEN BY TABLE 3 TO GIVE THE DISCHARGE OF THE SAME ORIFICE SUPPRESSED, COMPUTED FROM THE FORMULA $C=1+0.15r$, WHERE r =RATIO OF THE SUPPRESSED PORTION OF THE PERIMETER OF THE ORIFICE TO THE WHOLE PERIMETER. TAKEN FROM "MEASUREMENT OF IRRIGATION WATER" BY U. S. RECLAMATION SERVICE.

Size of orifice d, feet	Size of orifice		Bottom suppressed r	C	Bottom and sides suppressed	
	l, feet	A, square feet			r	C
0.25	1.0	0.25	0.40	1.06	0.60	1.09
	2.0	.50	.44	1.07	.56	1.08
	3.0	.75	.46	1.07	.54	1.08
0.5	1.0	.50	.33	1.05	.67	1.10
	1.5	.75	.37	1.06	.63	1.09
	2.0	1.00	.40	1.06	.60	1.09
	2.5	1.25	.42	1.06	.58	1.09
	3.0	1.50	.43	1.06	.57	1.09
0.75	1.33	1.00	.32	1.05	.68	1.10
	1.67	1.25	.34	1.05	.66	1.10
	2.00	1.50	.36	1.05	.64	1.10
	2.33	1.75	.38	1.06	.62	1.09
	2.67	2.00	.39	1.06	.61	1.09

One of the orifices described above, 2.0 feet wide and 0.5 foot high, has been installed at Davis and a series of tests made with discharges of from 1 to 2.2 cubic feet per second. The mean of all tests gave a coefficient for use in the formula given with the table of 0.61, which is the same as has been found in other experiments.

When properly installed this type of submerged orifice should give dependable results if the difference in head is correctly measured. Care should be taken to prevent silting in front of the orifice or the catching of drift.

SUBMERGED ORIFICE HEADGATES

This type of submerged orifice (Figs. 17 and 18) has been used to a large extent on systems where the small loss of head available makes

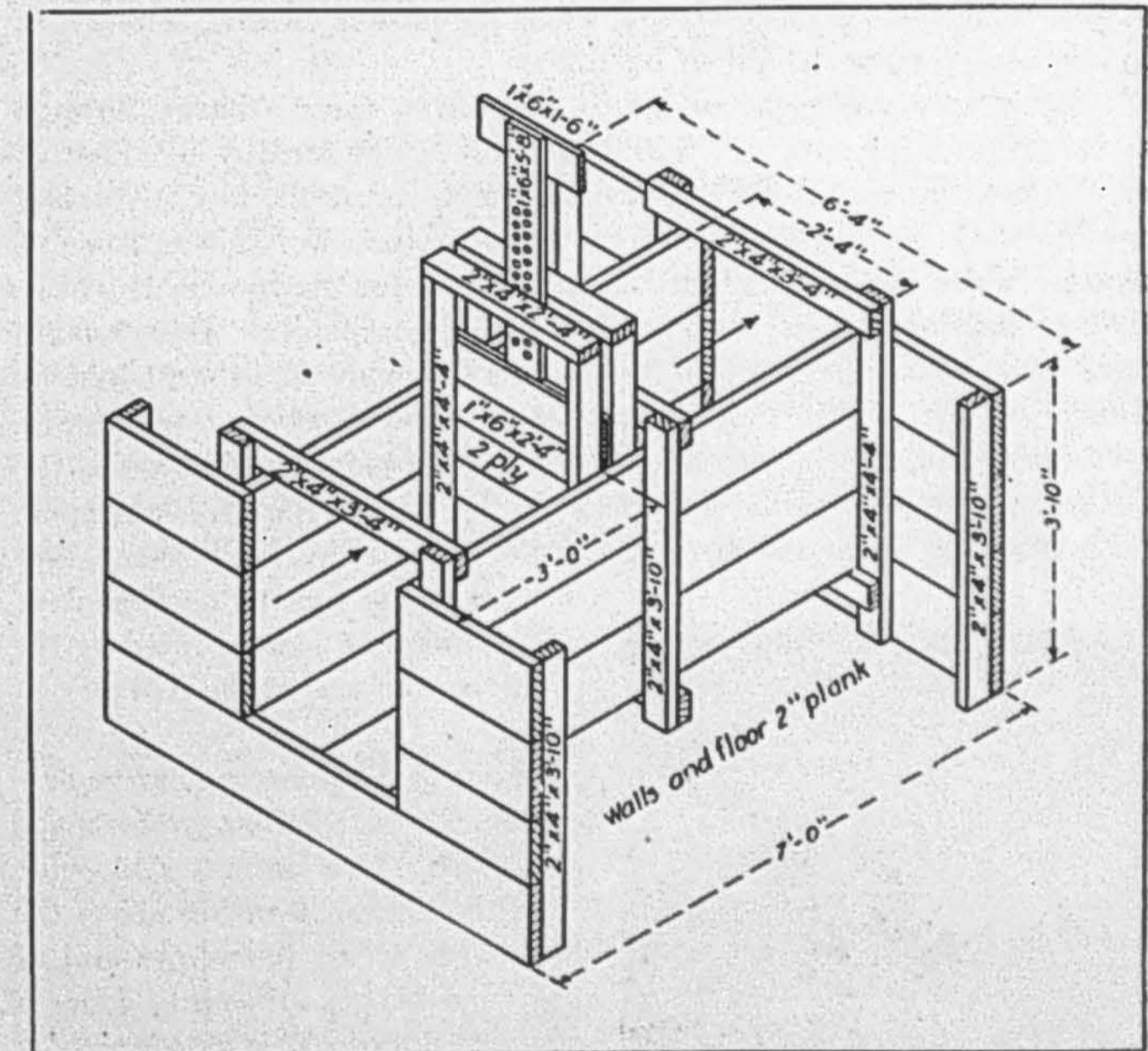

Fig. 17.—Drawing of submerged orifice headgate

a combination of headgate and measuring device necessary. While all such devices have many points of similarity, different canal companies have adopted slightly different forms as their standard.

The accuracy of measurement of water through a submerged opening depends on the measurement of the loss of head, the area of the opening, and the selection of the coefficient for use in the formula of discharge.

Measurements of the pressure for such gates are made in the same way as described for the submerged orifice with fixed opening. The best method is to make the measurements sufficiently far from the gate to avoid any sucking of the water on the upper side or rough water below. The pressure sometimes is determined by measuring down to the water surface on the upper and lower sides of the gate. This is a poor method as the water is liable to be drawn down below its true level above the gate and to shoot out from the gate below. The area of the opening is generally measured between a fixed mark on the gate stem and the top frame of the gate, the mark being placed so that it is even with the top of the frame when the gate is closed. The width is the same for any height of opening.

The proper coefficient to use in computing the discharge through such orifices is uncertain. Within general limits for any fixed set of conditions, the coefficient is probably nearly constant, but the actual coefficient to use may depend on many variables. For this reason discharge tables are not included. The values for sharp-edged orifices 0.61 or 0.62 have been used by some canal companies. It is certain that these values are too low for the orifices made of either 1-inch or 2-inch lumber. The Yolo Water and Power Co. have adopted a standard form of headgate 3 feet wide with spreading wing walls, the bottom of the gate being 1 inch above the floor. Experiments made with this gate under the direction of Professor B. A. Etcheverry gave a mean value for the coefficient of 0.73, which has been adopted by the company for use in the delivery of water.

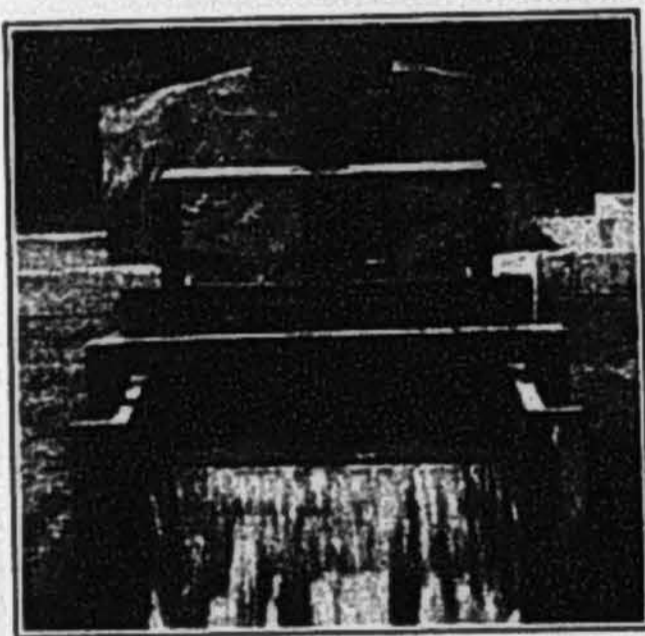

Fig. 18.—Photograph of submerged orifice headgate

Tests of a submerged orifice gate under two conditions were made at Davis. One gate 3 feet wide with the bottom 6 inches above the floor were set at the upper end of the turnout box diverting from a concrete flume. This gate is similar in type to the one shown in Figure 15. It was tested with discharges of from 0.50 to 4.25 cubic feet per second. The height of the side

walls prevented the use of larger discharges, although the gate can handle much larger heads. The loss of head was determined by measuring down from a level board above and below the gate and also on the gate. The mean of all measurements using the level board gave a mean coefficient of 0.80; the measurements on the gate gave a mean of 0.72, but were more variable than the others.

A similar gate set across the 3-foot wide concrete flume of the field laboratory was also tested, giving a mean value of 0.79 for the coefficient with level board readings. The discharges varied from 1.6 to 6.9 cubic feet per second in these experiments.

From these results it is seen that the coefficient for such measuring gates varies with the type of gate. It is possible that the coefficient would have been lower for higher rates of discharge at Davis if such tests could have been made.

There are several types of these gates in use in California. The gate used by Imperial Co. No. 1 is set 4 feet back from the front of the box. In the box used by the Kern County Land Co. the gate is set at the front, flush with the side of the canal.

Where the lack of sufficient fall for the use of a better measuring device makes the use of this type of submerged orifice necessary, a standard size and structure should be adopted, and special discharge tables prepared. This should then be rated under the condition in which it will be used. As long as the conditions of use can be maintained, fairly satisfactory measurements can be made. Care should be taken to prevent the deposit of silt or sand near the gate as this will change the conditions of discharge and affect the rating. The velocity above the gate should also be made as small as practicable.

Bill of Material for Submerged Orifice Headgate

	Board feet
12 pc. 2" × 12" × 2' (cut-off walls)	48
2 pc. 2" × 12" × 6'-4" (cut-off walls)	26
6 pc. 2" × 12" × 7'-4" (main walls)	88
2 pc. 2" × 12" × 7'-4" (floor)	30
1 pc. 2" × 4" × 7'-4" (floor)	8
6 pc. 2" × 4" × 3'-10" (posts)	15
4 pc. 2" × 4" × 4'-4" (posts)	12
4 pc. 2" × 4" × 4'-4" (gate posts)	12
3 pc. 2" × 4" × 3'-4" (caps)	7
3 pc. 2" × 4" × 3'-4" (sills)	7
2 pc. 2" × 4" × 2'-4" (gate caps)	3
3 pc. 2" × 12" × 2'-4" (gate)	14
1 pc. 1" × 6" × 7'-6" (gate stem)	4
Total	274

The cost of one of these orifice headgates in Imperial Valley is given by the Superintendent of Mutual Water Company No. 1 as about \$20. The items making up the total are, lumber about \$9; labor, exclusive of excavation, about \$8; excavation and incidentals, about \$3.

MECHANICAL DEVICES THAT MEASURE AND REGISTER THE TOTAL FLOW

It is stated in the introduction of this bulletin that to be fully satisfactory for measuring individual deliveries of irrigation water a device should register the total amount of water passing, rather than the rate of flow. Three devices of this character—Dethridge, Grant-Michell, and Hill meters—have been installed at Davis and tested. A fourth, the Hanna meter, is to be installed as soon as available, only a photograph and brief description of it being included herein.

DETHRIDGE METER

This meter is shown in figures 19 and 20. It was invented by Mr. J. S. Dethridge, of the State Rivers and Water Supply Commission of Victoria, Australia, and has been extensively installed in Victoria, where 5000 are now in use. It has also been used quite extensively in New South Wales.

The Dethridge meter consists of a wheel or drum to which projecting pieces of sheet metal are fastened. The drum is placed with its axle horizontal and is set so that the projecting blades are in the current of the ditch to be measured. A special box is built around the wheel so that all water in passing has to strike against the blades. In this way the wheel turns in proportion to the amount of water passing. Knowing the number of revolutions of the wheel the amount of water passed can be determined.

The illustrations given show one of these wheels set in a concrete box, but wooden boxes of similar form can be used. The whole structure is set just below the turnout gate, which is shown in the drawing. The bottom of the box is curved to fit the shape of the wheel. About $\frac{3}{8}$ inch of clearance is left between the box and the blades. In use the water comes against each blade and pushes it around until the next blade strikes the water. In this way the space between the blades is filled with water, which is carried through the meter. The meter shown seems to have a normal capacity of 4 cubic feet per second and can be crowded to carry 5 cubic feet per second. This higher quantity, however, causes splashing over the top of the box. The fall needed to turn the meter varies with the amount being

measured, from $\frac{1}{2}$ inch for 1 cubic foot per second to $2\frac{1}{2}$ inches for 4 cubic feet per second. This small required fall makes the use of this meter practicable in ditches with low grade. A counter is attached

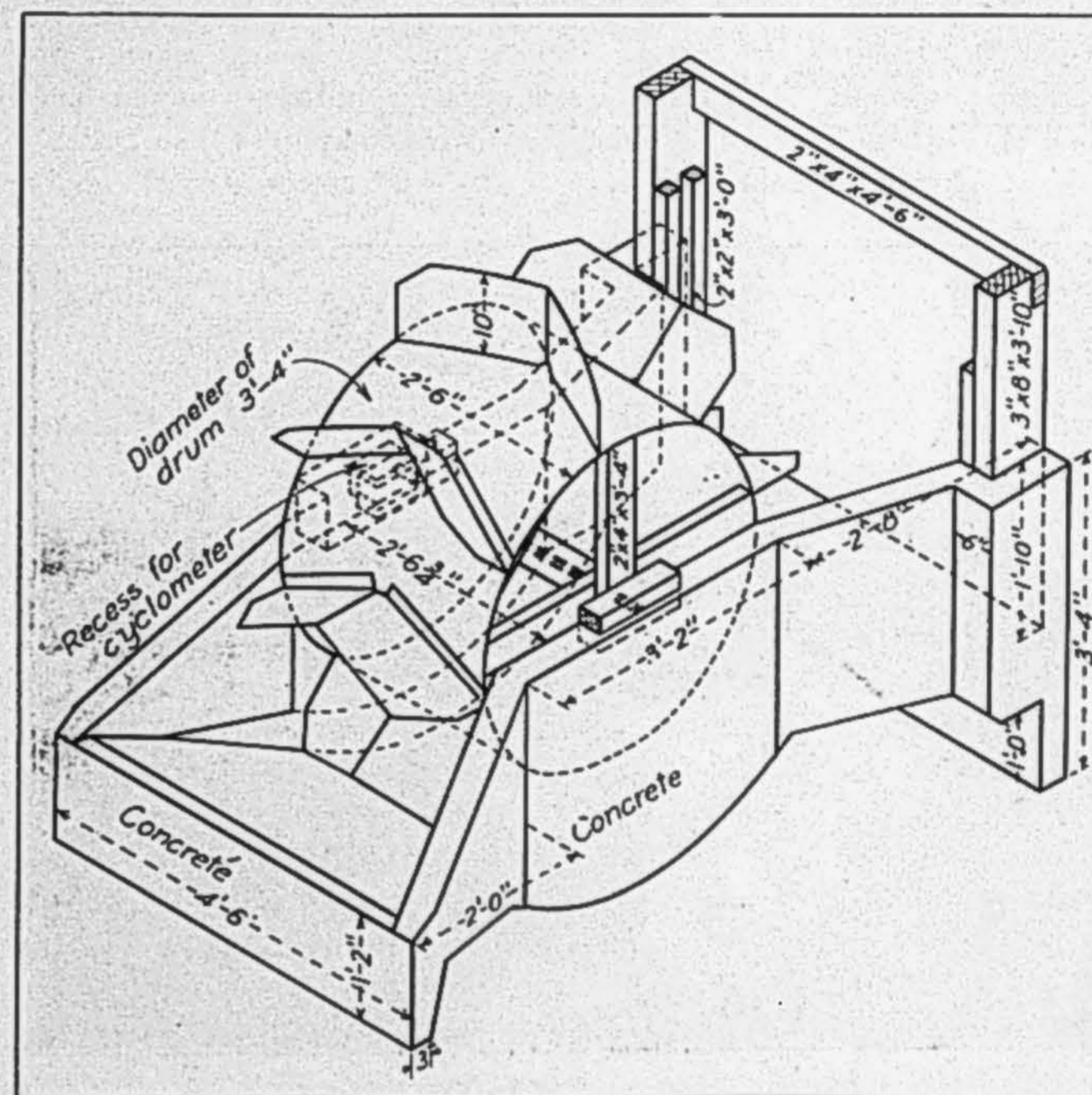

Fig. 19.—Drawing of Dethridge meter

to one end of the axle and this indicates the number of revolutions which the meter has made at any time. The difference in the reading of the counter at any two times gives the number of revolutions the meter has made between the times of reading. By multiplying this number of revolutions by the number of cubic feet passed per revolution, the total quantity of water received can be determined. It is most convenient to transfer the water received into terms of acre-feet.

If it is desired, with the Dethridge meter, to know the rate at which water is being received at any time it is only necessary to time the meter for one or more complete revolutions and divide the quantity passed per revolution by the time for one revolution. Thus, if it takes 30 seconds for the meter to make one complete turn and it is known

from its rating that it passes 30.5 cubic feet for each turn, the rate of flow is 30.5 divided by 30, or a little over one cubic foot per second.

The walls of the box in which the Dethridge meter is set are 4 inches thick when made of concrete. Care should be used in getting the bottom curved to the correct circle so that the leakage around the meter will be small. This meter is somewhat complicated in construction and it is better for it to be placed by canal companies than by land owners. It will probably cost less in this way as the drums can be

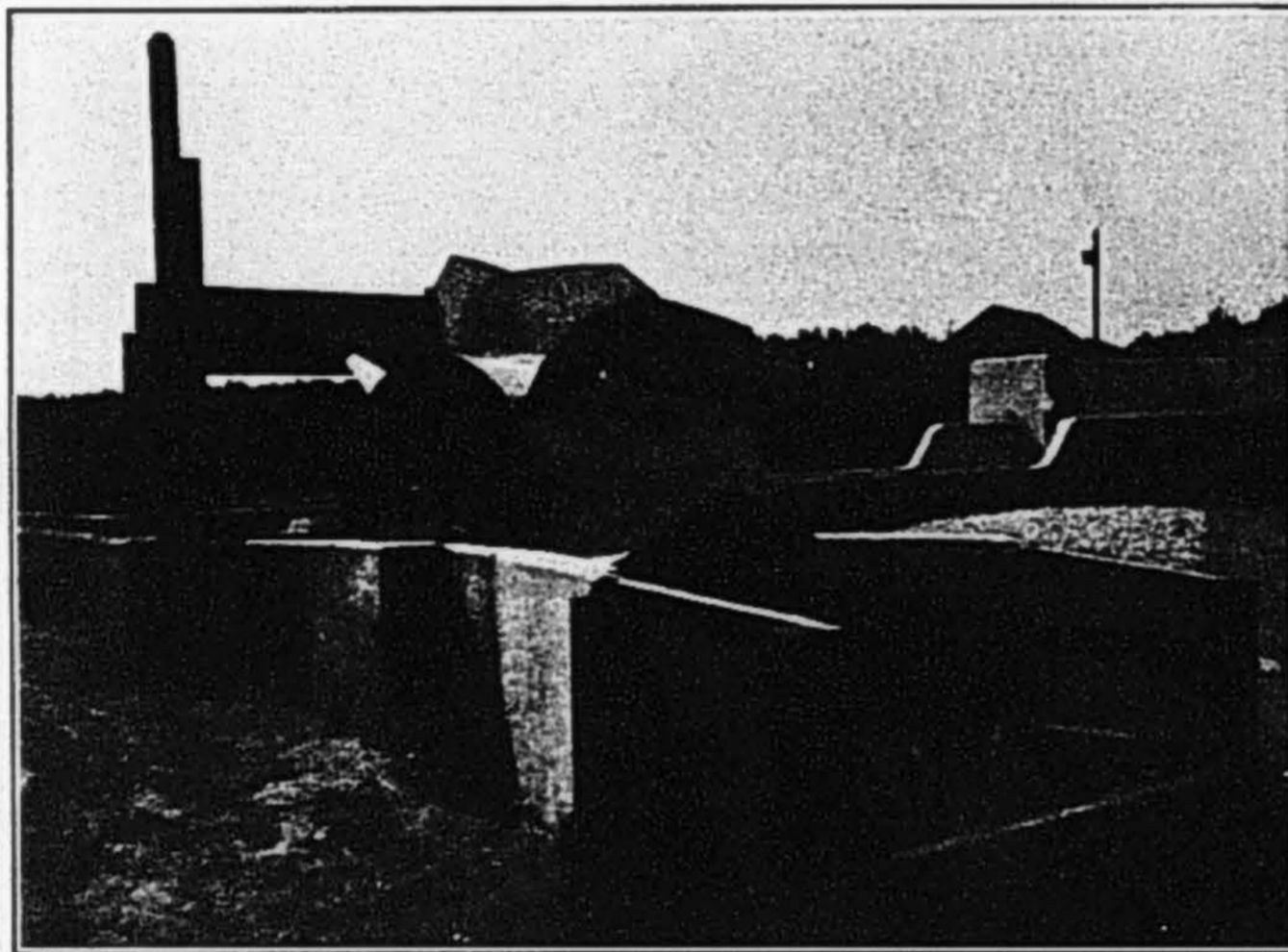

Fig. 20.—Photograph of Dethridge meter

bought in quantities. In Australia the concrete box is made in parts and seasoned in the material yard, the parts being then cemented together when placed in the field. When built of concrete as shown in figures 17 and 18, 22.8 cubic feet of concrete and 40 board feet of lumber are required. The drums are best made by some sheet metal works. A special counter should be used made of rust resistant metal as the ordinary counters have been found to rust out rapidly in use. Where installed in large numbers in Australia the cost has been about \$40 per meter; the cost of the meter installed at Davis was about \$60.

The tests of this device made at Davis showed the meter to be quite accurate under constant ditch conditions between rates of flow of 1 to 3.5 cubic feet per second. For both larger and smaller discharges the

meter passes more water than it does between these limits. The amount of water going through the meter varies with the depth of drowning. A meter set high in the ditch will discharge less water per revolution than one set low. Checking up the ditch below a meter so that the depth is increased at the meter may increase the discharge by as much as 10 per cent in some cases. This is discussed in detail in the appendix.

The Dethridge meter of this size is adapted for accurate measurement of streams varying from 1 to 3 or 4 cubic feet per second; in Australia it is considered satisfactory up to 5 cubic feet per second. Where the quantities are either larger or smaller than these amounts the error will be in favor of the water user. While rather expensive to install there are no parts which will wear out except possibly the counter. The bearings are merely oiled wooden blocks. Variations in the friction will not alter the discharge; if the bearings are tight a greater fall will be needed to drive the wheel, but unless tighter than they will become if not tampered with, the discharge per revolution will not change. Where larger amounts are to be turned out, larger meters can be built or more than one installed. The meter has the advantage of being easily understood. The wheel stands up in the air and has a clumsy appearance, yet it is some advantage to be able to look across the field to the turnout and see by the turning of the wheel that water is still coming. When users realize that every turn of the wheel means so much water charged to them they will be more liable to economize in its use.

Bill of Material for Dethridge Meter

In addition to the 22.8 cubic feet of concrete required for this meter and the galvanized iron wheel, the following lumber is necessary:

Bill of Material for Dethridge Meter

	Board feet
1 pc. 3" × 4" × 4'-6"	4
2 pc. 3" × 8" × 4'	16
1 pc. 2" × 4" × 4'-6"	3
4 pc. 2" × 1½" × 3'	3
4 pc. 2" × 4" × 1'	3
1 pc. 2" × 8" × 4'-6"	3
1 pc. 1¼" × 6" × 4'	3
1 pc. 1¼" × 6" × 5'	3
1 pc. 1¼" × 6" × 2'-4"	2
Total	40

GRANT-MICHELL METER

This meter is shown in figures 21 and 22. It consists of a wheel turning in a horizontal circular opening through which the water is made to pass. This opening sets a little below the bottom of the ditch. The water in entering drops into a box set below the ditch bottom.

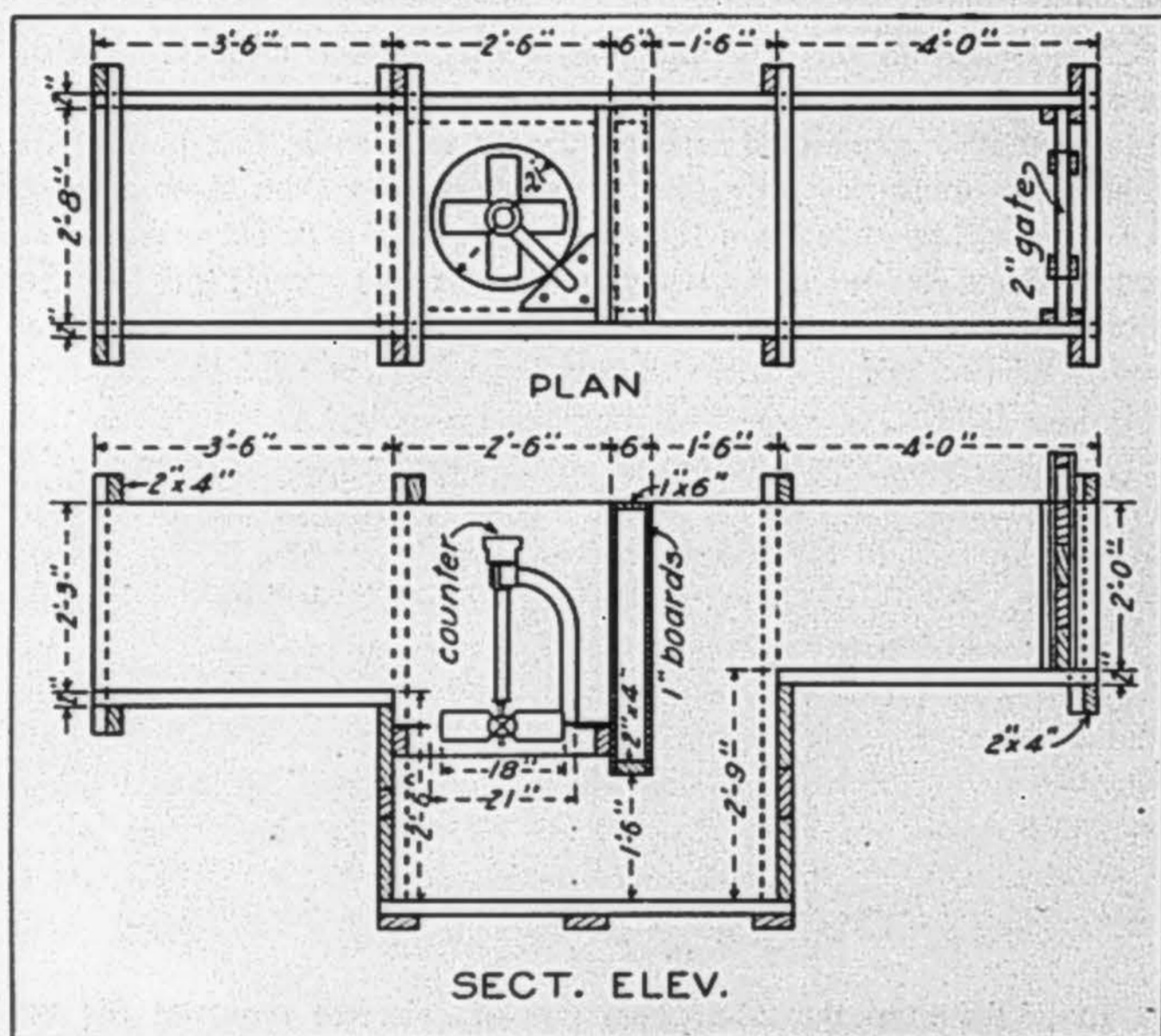

Fig. 21.—Plan and elevation of installation of Grant-Michell meter

passes under a cross wall, rises through the circular opening in which the meter is set, and passes on down the ditch. The meter consists of four flat blades set so that the water in flowing through the circular opening strikes against them at an angle. In this way the wheel is turned similarly to a wind mill. On the upper end of the shaft carrying the wheel is a counter which records the number of revolutions of the wheel.

This meter is made in 4 sizes, 12-inch, 18-inch, 21-inch, and 39-inch. The size to be used is determined by the size of the circular opening. The rated capacities for these sizes given by the makers are 1.66, 3.75, 5.83 and 16.66 cubic feet per second, respectively. The

wheel, counter, and standard for holding the wheel are sold and controlled by the patentees or their licensed agents. The prices quoted for Pacific Coast delivery, in lots of not less than 6, with freight but not duty paid, are \$52.25, \$66.75, \$74.20 and \$170.30, respectively, for the four sizes. The meter was invented by the two Australian engineers for whom it is named and has been used to some extent in that country, but it has been but little used in the United States. The box for the meter can be built of either wood or concrete; that installed at Davis is of wood. The standard for holding the meter is arranged so that the meter can be removed when not in use. On systems where the flow through each meter is not continuous, the meter can be used on more than one ditch, being moved around as water is turned out.

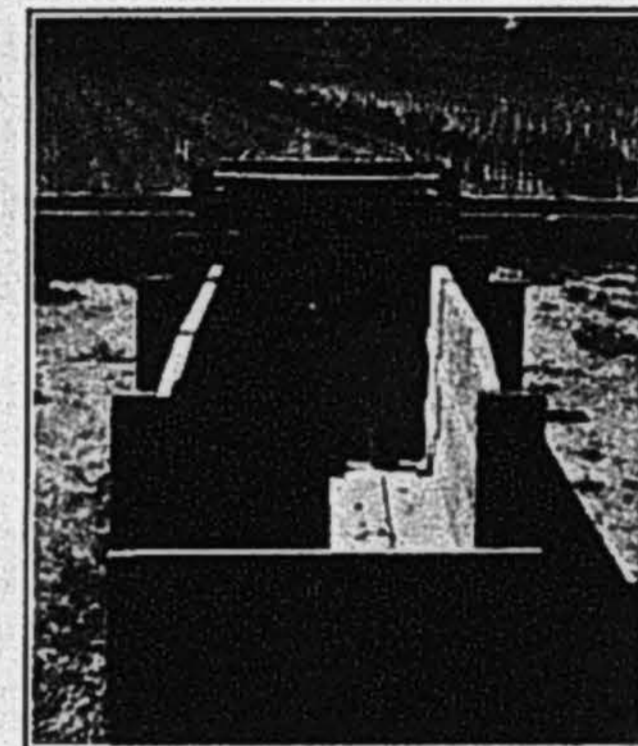

Fig. 22.—Photograph of installation of Grant-Michell meter

The tests made at Davis of a 21-inch Grant-Michell meter showed that for discharges of over 2 cubic feet per second and up to 6.5 cubic feet per second, the meter makes one revolution for every 6.1 cubic feet of water passed. More water is passed per revolution on lower rates of discharge. The 24 tests made show that the meter will probably register within 2.5 per cent of the true quantity. The fall required in the ditch to get the water through the meter varies with the rate of flow. It is about 1 inch when the discharge is 3 cubic feet per second and rises to 4 inches with a flow of 5 cubic feet per second.

This meter is not as much affected by changing the depths of water on the lower side as some others. The tests at Davis were made with varying depths but showed no regular differences. This is an advantage when used on a ditch which is sometimes checked up. Its high cost, however, is against its general use.

HILL METER

This device is shown in figures 23 and 24. It consists of a circular opening set horizontally in the floor of a box through which the water to be measured is made to pass. The meter consists of curved vanes set on a central drum. It sets in the center of the opening and is turned

by the water as it strikes against the vanes on rising through the opening. The turning of the meter drives the gears of a counting device

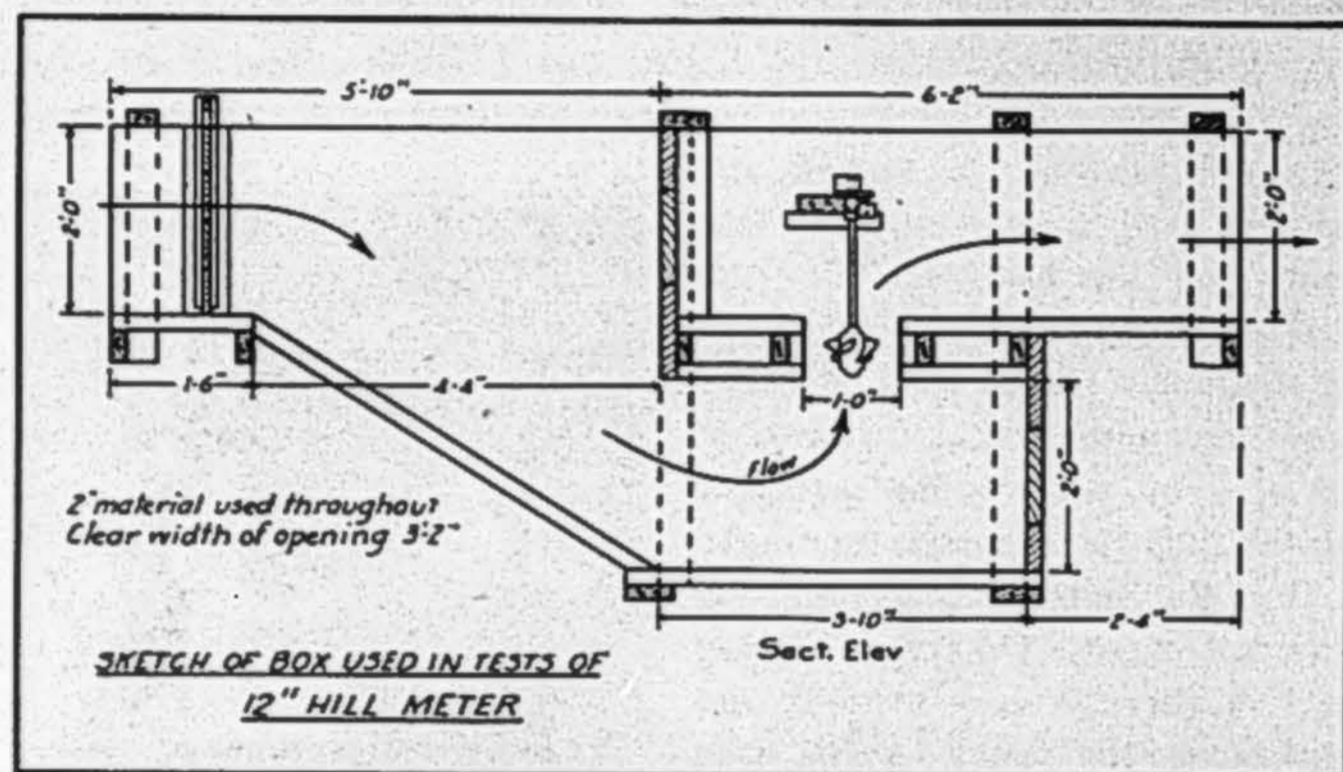

Fig. 23.—Sectional elevation of installation of 12-inch Hill meter

which records the water passed in acre-feet. Different sized openings and meters are used for different sized quantities of water. The box in which the meter is set resembles a siphon.

The Hill meter is patented and must be bought of the patentee or his licensed agents. While it has not been used to any extent as yet, and has not been pushed commercially, it is estimated that the meter alone, when manufactured in quantities, should cost about \$10 each for the 12-inch size and about from \$12 to \$15 for the larger size, with a probable reduction with very large quantities. The cost of the structure for holding the 12-inch meter will vary from \$10 to \$15. It is stated by those who have developed this meter that any kind of orifice in which the meter can be inserted so that its axis is vertical will do very nicely after the meter has been calibrated to suit that type of orifice.

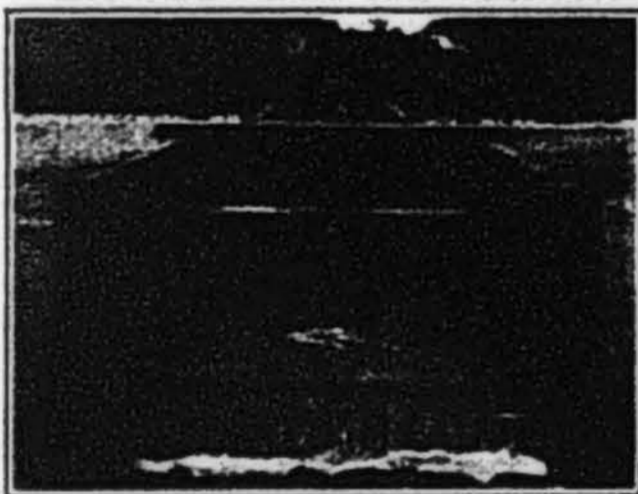

Fig. 24.—Photograph of installation of 12-inch Hill meter

From a test of a 12-inch Hill meter at Davis it appears that this size of the meter will register the quantity passed within 1.5 per cent for discharges of from 1 to 3.5 cubic feet per second. For discharges

of less than 1 cubic foot per second, more water passes the meter than is registered. For discharges of 3.5 cubic feet per second the water boiled up through the opening so as to submerge the counter of the meter tested. By increasing the length of shaft of the meter higher discharges than this can be crowded through the 12-inch meter, but the greater loss of head required makes the use of larger meters preferable.

The loss of head or fall in the water required for this meter varied from 1 inch, when carrying 1 cubic foot per second, to 6½ inches, when carrying 3.5 cubic feet per second.

The Hill meter seems adapted to use under the usual conditions of irrigation practice. It is simple and has few wearing parts. The head required for the different sizes is less than that needed for the use of weirs. The record of the total quantity of water passed can be read in units of .001 acre-foot.

HANNA METER

As before stated, a Hanna meter has not yet been tested in the Davis laboratory. This meter has been designed by Mr. F. W. Hanna, supervising engineer of the U. S. Reclamation Service. The present retail price is \$50. Figure 25 is taken from a photograph of one of these meters; figure 13 shows one installed with a Cipolletti weir.

The Hanna meter differs from the Dethridge, Grant-Michell, and Hill meters previously described in being a device that registers the quantity passing through some other device rather than itself making the measurement. It differs from an ordinary water register in that it registers the quantity of water passing rather than merely the height of the water in some device. It can be installed in connection with a weir, a rating flume, an open channel, or a submerged orifice, or an orifice with free discharge, and will indicate on a counter, directly in acre-feet, the quantity of water passing. The mechanism of the meter is inclosed

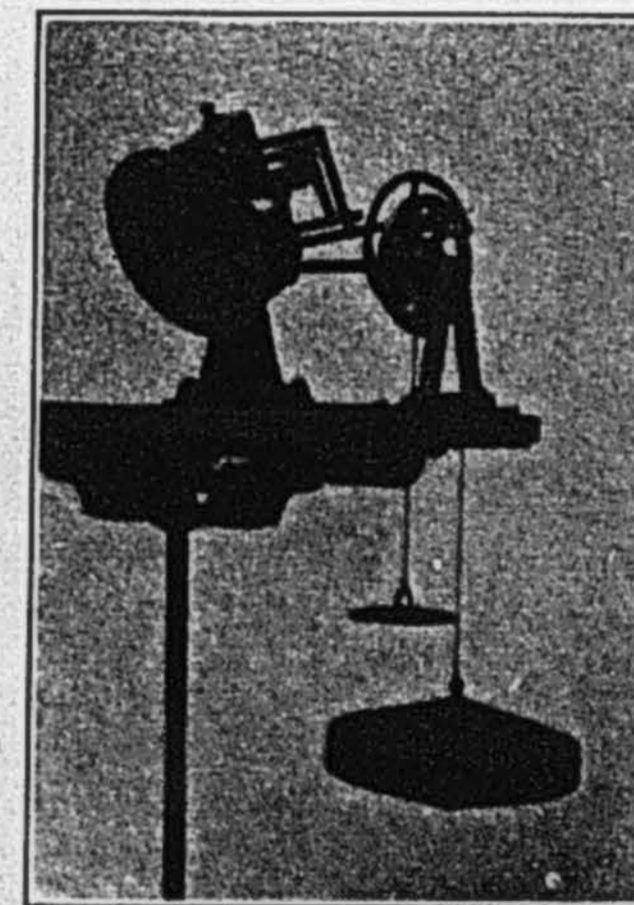

Fig. 25.—Photograph of Hanna meter

in a dust-proof metal box, shown in figure 13, and when installed this metal box rests on the top of a stilling box, also shown in the illustration, which communicates through a pipe with the stream being measured. A float resting on the water of the stilling box and an 8-day clock together operate the meter.

WATER REGISTERS

Reference is made in the preceding pages to water registers for recording the height of water flowing over a weir or in a ditch or flume.

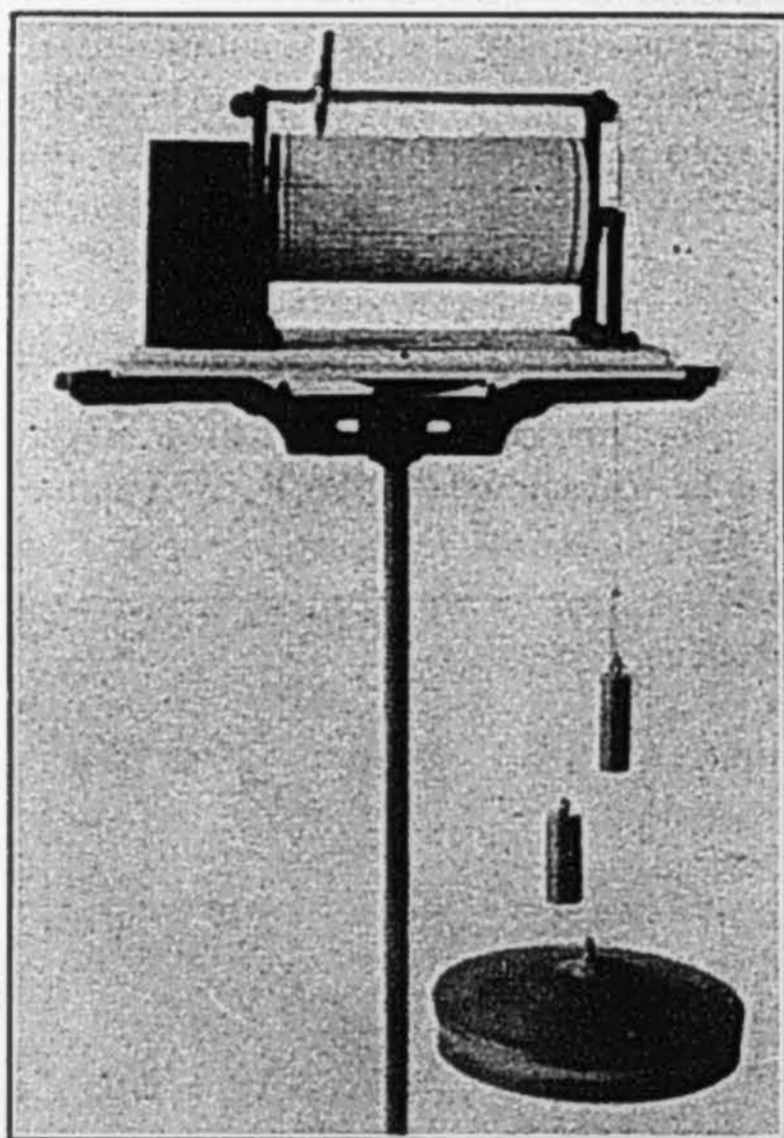

Fig. 26.—Photograph of a water register

In the main a water register (fig. 26) is composed of a cylinder on which a record sheet is fastened, a float which causes this cylinder to rotate as the water being registered raises and lowers, and an eight-day clock which causes a pencil to travel horizontally the length of the cylinder each week, marking on the record sheet the height of the water as it travels. Water registers are usually set at the side of the ditch or weir carrying the water being measured, the float and counter-weight hanging in a stilling well, as shown for the Hanna meter (fig. 13) just described. The register sheets fastened on the cylinder are ruled horizontally to show feet and fractions of feet and vertically to show days and fractions of days. These sheets are changed once each week. To make use of the record they furnish it is necessary to use discharge tables giving the flow with different depths of water for the weir or flume in connection with which the register is set. As a rule water registers are not adapted to farm use. They require constant care and attention and, as indicated, considerable computation is necessary to determine from the register sheets and the discharge tables the quantity of water that has passed.

CURRENT METERS

The standard instrument used for measuring the velocity of water in ditches and other open channels is the current meter. One of these instruments, with its full equipment, is shown in figure 27. Current meters are not used by farmers but one should be a part of the equipment of every canal superintendent or irrigation manager. They are mentioned here merely with the hope of encouraging their wider use by canal companies which have not been accustomed to use them and to make them generally familiar to farmers. Ordinarily it is not feasible to measure the water carried in main canals and main laterals by means of the devices that have been described in this Bulletin. Instead current-meter ratings are made at selected portions of the main canals and main laterals and from these tables are computed showing the quantity of water flowing at various depths. Standard types of current meters cost from about \$75 to about \$90, depending upon the style and equipment. As engineers and canal superintendents and irrigation managers are familiar with these instruments no description needs to be added.

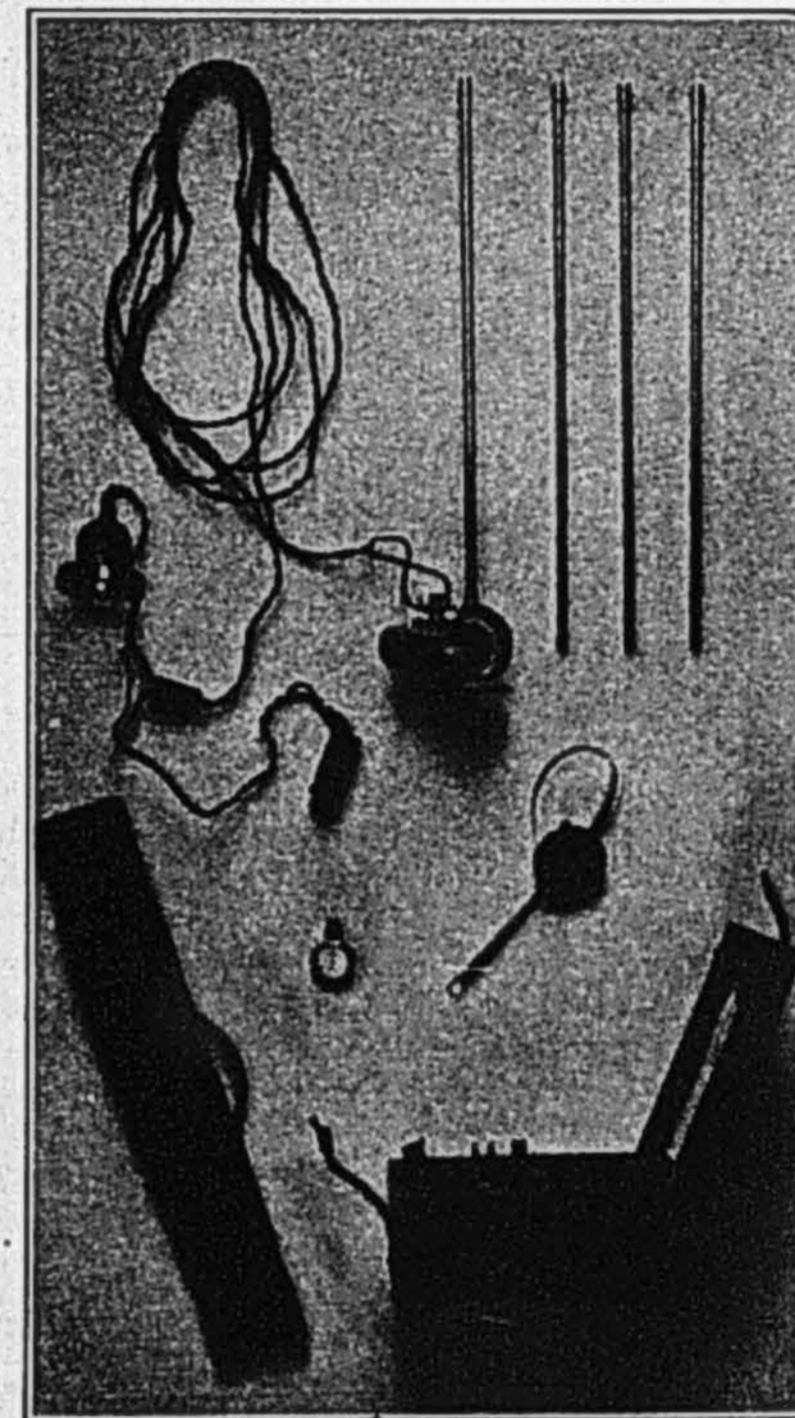

Fig. 27.—Photograph of current meter and equipment

APPENDIX

DATA AND DISCUSSION OF TESTS OF MEASURING DEVICES AT DAVIS FIELD LABORATORY, JANUARY TO MARCH, 1914

Experiments and Discussion by S. T. HARDING

I. AZUSA HYDRANT. (Figures 3 and 4)

SUMMARY OF EXPERIMENTS

Area of opening in hydrant gate, square inches (equivalent to discharge, miner's inches)	Difference in discharge of orifices and weir, or error of measurement by orifices, per cent	Area of opening in hydrant gate, square inches (equivalent to discharge, miner's inches)	Difference in discharge of orifices and weir, or error of measurement by orifices, per cent
10	+6.31	50	+0.85
10	-2.98	50	+2.00
15	+3.65	10 + 15 + 25 = 50	+1.00
25	+1.80	10 + 50 = 60	-1.38
25	+5.80	15 + 50 = 65	-0.39
10 + 15 = 25	+1.50	25 + 50 = 75	-2.20
10 + 25 = 35	+1.50	10 + 15 + 50 = 75	-1.30
10 + 25 = 35	+3.68	10 + 25 + 50 = 85	-0.84
15 + 25 = 40	+1.70	15 + 25 + 50 = 90	-2.14
15 + 25 = 40	+0.37		
		Mean	2.18

Probable error of a single measurement +1.0.

II. GAGE HYDRANT. (Figures 5 and 6)

This hydrant consists of a 10-inch rectangular weir set in an opening in a vertical concrete box. The weir crest consists of pieces of iron strap 1/8-inch thick set in mortar in the middle of the thickness of the box. It may be classed as having full contractions, although the nearness to the sides of the opening and to the sides of the box probably affects the contraction. The detail of the crest is shown in the drawing.

The experiments with this device consisted of 16 measurements with quantities varying from 0.15 to 1.13 cubic feet per second. The results of these are platted on the accompanying diagram. A hook gage was set in the back corner of the box with its zero point level

with the crest of the weir. A can 3 inches in diameter was used as a stilling box for this gage. Although the holes in this can were small, difficulty was experienced in getting accurate readings of the head due to the apparent "breathing" of the water, particularly at the higher heads. It is considered that this is the principal cause for the variation of the results of the separate measurements from the curve as shown on the diagram. Cross currents were very noticeable in the water in the box at the higher heads. Small shavings dropped

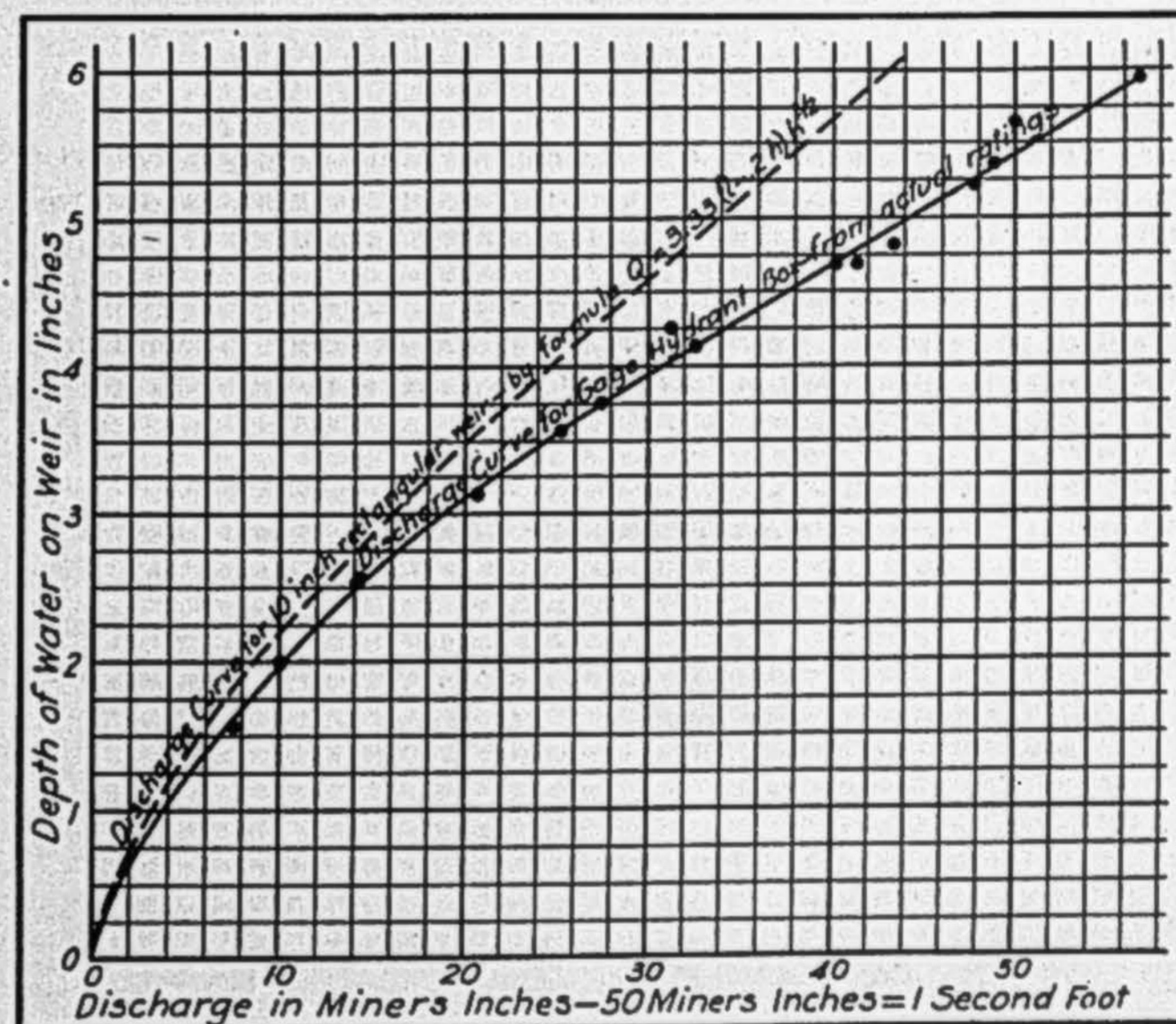

Rating Curve for Gage Hydrant

into certain parts of the surface of the water would be sucked several inches below the crest of the weir before passing over it. Under such conditions it is not to be expected that the standard weir formula would apply. For purposes of comparison the discharge of a 10-inch weir computed from the formula $Q = 3.33 (1 - .2 h) h^{3/2}$ is plotted on the diagram. This shows the device to give increasingly greater discharges than a similar standard weir as the head increases.

The half-round section of 18-inch pipe used as an outlet for the water after it passes the weir was of sufficient size to discharge the

water received without submerging the weir. However, at the higher heads used the water below the weir was but little below the crest of the weir. The accuracy of measurements with this device under field conditions will depend to a considerable extent on the accuracy with which the reading of the head of the crest can be made. The usual method is to set a bracket at the back side of the box with its top level with the discharge crest. By setting a rule on this bracket the depth can be read directly. With the hook gage and stilling box used in these experiments the average variation of the 16 measurements from the curve was 3.5 per cent. With measurements of the head in open water the error to be expected would be much greater.

Some measurements were also made on this hydrant before the sharp edge was set, using the 2-inch concrete wall as a discharge crest. The heads were read on a staff gage, the water being stilled in front of this with a piece of wood at the times of the readings. A total of 7 measurements were made, with discharges varying from 0.18 to 0.96 cubic foot per second. The crest was 13⁵/₈ inches long. A comparison of the rating curve obtained from these measurements with a computed curve for a sharp crested weir of the same length showed that on the lower heads, where the thickness of the concrete is sufficient to give broad crested weir conditions, the discharge is less than for a sharp crested weir, and that on the higher heads, where the lower contraction is complete, the measured curve gives higher discharges than the sharp crested weir, being similar to the results on the same box after a sharp edge was installed.

SUMMARY OF EXPERIMENTS

Head on weir, feet	Actual discharge, cu. ft. per. sec.	Computed discharge, $Q=3.33(l-2h)h^{3/2}$, cu. ft. per sec.	Difference, per cent	Head on weir, feet	Actual discharge, cu. ft. per sec.	Computed discharge, $Q=3.33(l-2h)h^{3/2}$, cu. ft. per sec.	Difference, per cent
0.128	0.152	0.121	26	0.355	0.627	0.537	16
.166	.202	.180	12	.392	.804	.617	30
.211	.288	.253	14	.393	.829	.618	34
.213	.284	.258	10	.401	.864	.633	36
.260	.413	.343	20	.435	.958	.709	35
.298	.506	.418	21	.446	.978	.735	33
.313	.548	.442	24	.471	1.000	.795	26
.342	.652	.509	28	.494	1.134	.846	34

III. RIVERSIDE BOX (Figures 7 and 8)

SUMMARY OF EXPERIMENTS

Area of opening in gate, sq. in. (equivalent to discharge in miner's inches)	Difference in discharge of orifice and weir, or error in measurement by orifice, per cent	Area of opening in gate, sq. in. (equivalent to discharge in miner's inches)	Difference in discharge of orifice and weir, or error in measurement by orifice, per cent
10.	+4.10	40.	-1.9
10.	-3.38	40.	+0.40
14.6	+4.45	43.	+3.16
15.	+1.86	44.5	+2.3
15.	+1.46	48.	+ .41
20.	-3.54	50.	+1.59
25.	-1.11	50.	+4.05
25.	+4.70	57.5	+1.25
27.5	-1.53	58.	- .16
32.5	+3.03	65.	- .26
33.	+0.15	75.	-1.63
35.	+1.00	75.	-1.08
		Mean.....	+1.95

IV. FOOTE INCH BOX (Figures 9 and 10)

SUMMARY OF EXPERIMENTS

Length of opening in box, inches	Discharge measured by box = length times height (4), = miner's inches	Discharge measured by weir, miner's inches	Difference in discharge, or error of measurement by box, per cent
41 ¹ / ₁₆	18.75	19.50	-4.00
63 ¹ / ₁₆	25.25	24.95	+1.19
83 ¹ / ₁₆	32.75	32.25	+1.53
95 ¹ / ₁₆	37.25	36.50	+2.01
11 ¹ / ₂	46.00	44.70	+2.83
15 ¹ / ₄	61.00	60.20	+1.31
16 ¹ / ₁₆	66.75	62.95	+5.69
19 ¹ / ₄	77.00	72.45	+5.91
20	80.00	78.85	+1.44
21 ¹ / ₄	85.00	79.40	+6.59
22 ¹ / ₂	90.00	86.50	+3.89
25 ⁵ / ₁₆	102.50	95.40	+6.92
27 ¹ / ₁₆	110.75	101.95	+7.93
29 ⁵ / ₁₆	117.50	108.90	+7.32
31 ¹ / ₄	125.00	118.75	+5.00
32 ¹ / ₁₆	128.25	124.50	+2.92
37 ¹ / ₁₆	148.25	147.40	+0.58
		Mean.....	+3.95

SUMMARY OF EXPERIMENTS ON SUBMERGED ORIFICE HEADGATE SET IN A 3-FOOT CONCRETE FLUME. GATE 31 $\frac{1}{2}$ INCHES WIDE

No. of run	Dis-charge, cu. ft. per sec.	Height of opening, inches	Area of opening, sq. ft.	Loss of head by, in feet				Coefficient in formula $Q = AC\sqrt{2gh}$ from —				Depth of submergence, feet	Variation of coefficient from, mean				Velocity through orifice, feet per sec.				
				Hook gages	Staff gages	Level board	On gate	Hook gages	Staff gages	Level board	On gate		Hook gages	Staff gages	Level board	On gate					
1	2.09	5	1.10	.061	.06	.08	.11	.959	.967	.835	.713	.25	+.091	+.133	+.045	-.001	1.9				
2	1.97	4	.88	.091	.10	.10	.14	.92	.880	.878	.746	.33	+.052	+.046	+.088	+.032	2.24				
3	1.80	3	.66	.170	.17	.20	.21	.821	.821	.760	.740	.40	-.047	-.013	-.030	+.026	2.72				
4	1.62	2	.44	.328	.33	.35	.34	.802	.798	.775	.786	.51	-.068	-.036	-.015	+.072	3.68				
5	3.15	5	1.10	.192	.20	.22	.26	.817	.798	.761	.700	.42	-.051	-.036	-.029	-.014	2.86				
6	2.95	4	.88	.246	.25	.28	.34	.843	.841	.790	.715	.45	-.025	+.007	0	+.001	3.35				
7	2.72	3	.66	.356	.41	.46	.50	.860	.802	.757	.724	.53	-.028	-.032	+.033	+.010	4.12				
8	1.92	2	.44	.778	.77	.78	.86	.821	.827	.821	.784	.83	-.047	-.007	+.031	+.070	4.45				
9	1.74	2	.44	.370	.37	.36	.43	.807	.807	.819	.751	.45	-.061	-.027	+.029	+.037	3.94				
10	4.05	6	.132	.169	.19	.25	.37	.931	.878	.749	.629	.33	+.063	+.034	-.041	-.085	3.07				
11	3.83	5	1.10	.252	.28	.30	.45	.865	.880	.793	.647	.37	-.003	-.014	+.003	-.067	3.48				
12	3.51	4	.88	.316	.36	.39884	.830	.79633	+.016	-.004	+.006	3.99				
13	3.16	2 $\frac{1}{2}$.63	.47	.52	.58905	.866	.81925	+.037	+.032	+.029	5.00				
14	2.85	2	.44	.90	.96	1.06850	.826	.77828	-.018	-.008	+.012	6.48				
15	5.12	7	1.5431	.39	.37745	.663	.681	.56	-.089	-.127	-.033	3.32				
16	4.79	6	1.3234	.35	.44775	.775	.691	.35	-.059	-.015	-.023	3.63				
17	4.36	5	1.10	.332	.39	.41	.51	.858	.791	.771	.692	.34	-.010	-.043	-.019	-.022	3.96				
18	3.93	4	.88	.394	.43	.51887	.848	.81022	+.019	+.010	+.020	4.46				
19	3.60	3	.6655	.74915	.79336	+.071	+.003	5.45				
20	3.11	2	.44	1.07	1.07851	.85130	+.017	+.061	7.07				
21	6.92	7	1.54	.38	.43	.46909	.854	.82537	+.041	+.020	+.035	4.49				
22	6.16	6	1.32	.425	.51	.56893	.816	.77833	+.025	-.018	-.012	4.66				
23	5.65	5	1.10	.539	.60	.69872	.827	.78143	+.004	-.007	-.009	5.14				
Mean of all experiments,								.868	.834	.790	.714037	.033	.030	.035	
Probable error of any observation, per cent,								4.3	4.0	3.8	4.9

size of gate should be adopted and strictly adhered to. This should then be rated for the conditions of use, using the same method of reading the loss of head that will be used in practice. The coefficient derived from the rating should then be used for the type of gate rated. In use, care should be taken to maintain the conditions under which the rating was made and prevent silting of the channel above or other changes.

VI. DETHRIDGE METER. (Figures 19 and 20)

This device was tested by running water through it which had been measured over a weir and also volumetrically measured from the reservoir. The rate of flow was kept practically constant. The time of run, number of revolutions, and rate of flow gave data on which the number of cubic feet passed per revolution could be computed. Gages were set above and below the meter from which the loss of head could be obtained.

The installation of the meter is shown in the drawing. Immediately at the lower end of the concrete there was a drop into the waste channel. When first tested the water passed through the meter over 18 inches of floor, and then had a free fall to the waste channel. The measurements in this first test were representative of one extreme of conditions under which the meter might be installed. The rating curve derived from them is marked No. 1. Later a section of flume 3 feet wide and 12 feet long was built out from the concrete. This was similar to the usual ditch conditions, the water having a greater depth over the lower sill of the meter than in the first run. The rating curve derived from these tests is marked No. 2. The rating curve furnished by the State Rivers and Water Supply Commission of Victoria is shown by dotted line adjacent to curves Nos. 1 and 2.

In addition to the tests mentioned above, checks were placed in the flume and four single tests were made with different depths of submergence. The figures obtained are shown in the table of results and are plotted above rating curve No. 2.

Rating curve No. 1 agrees very closely with that used in Victoria. It is the practice there to set the floor of the meter box rather high in the laterals. The full supply level shown on their drawings is about 10 inches below the axle of the meter. By setting the meter high in the ditch, more constant conditions are secured, as checking of the lateral below can not submerge the meter to as great an extent. However, this requires an additional fall below the meter which is not always available. The conditions obtained in the second run are

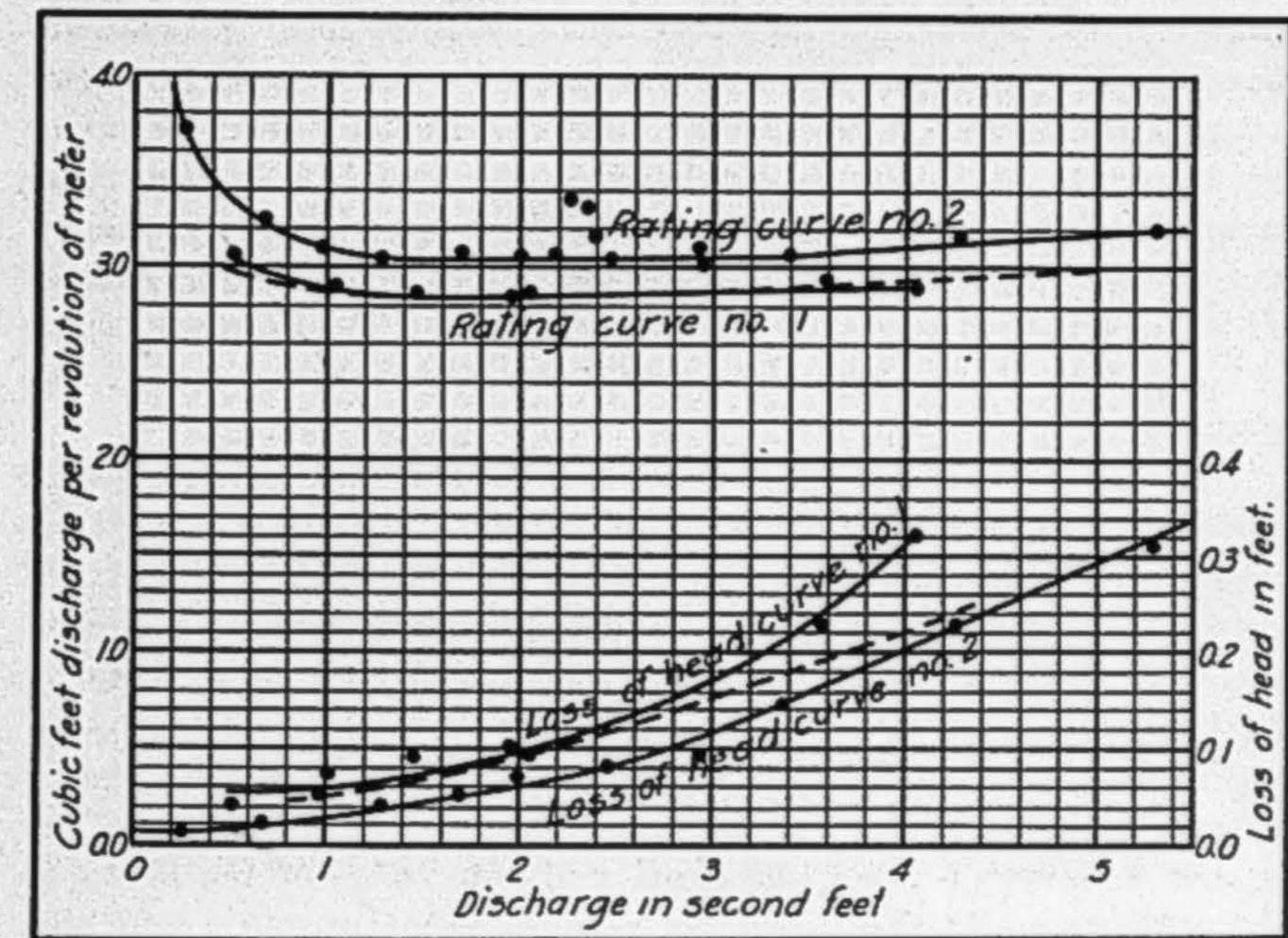

ERRATUM: "Grant-Michell Meter," in title to curves on page 173, should read "Dethridge Meter."

Each curve is consistent within itself. In curve No. 1 the average variation from the curve of the 7 points used to locate the curve is only 0.1 of a cubic foot per revolution, or about $\frac{1}{3}$ of 1 per cent. In curve No. 2 the average variation from the curve of the 12 points used to locate the curve is 0.15 of a cubic foot per revolution, or $\frac{1}{2}$ of 1 per cent.

With a meter of this type, which records in total quantities passed without showing the rate of flow, the ideal rating curve is a straight line which should be horizontal on the diagram. The discharge per revolution would then be independent of the rate of flow. It is not to be expected that this result can be obtained at either extreme of the capacity of any meter. With smaller discharges the leakage would be expected to be greater due to the slower movement of the wheel. Also, at higher discharges the greater depth of flow through the meter increases the leakage area. Both curves show this feature of increasing discharge per revolution at either low or high discharges. The range of capacity for this size wheel is considered to be from 1 to 4

cubic feet per second. A uniform rating is used between these discharges. The mean quantities discharged per revolution of the meter for all tests between 1 and 4 cubic feet per second were 28.75 cubic feet on curve No. 1 and 30.4 cubic feet on curve No. 2. The mean variation of the six tests on curve No. 1 from this average was 1 per cent and on curve No. 2, $\frac{2}{3}$ of 1 per cent. Under conditions such as existed in either of these runs the use of 15.2 and 14.3 revolutions per 0.01 acre-foot should give close results on curves Nos. 1 and 2, respectively.

Four additional tests were made with discharges of a little over 2 cubic feet per second, the depth of submergence being varied by checks in the flume. With depths of water of 0.45, 0.77, 1.01, and 1.20 feet on the lower sill of the meter, the quantities discharged per revolution of the meter were 30.5, 31.5, 32.5, and 33.0 cubic feet, respectively.

The height of the blades is 10 inches, the diameter of the drum is 3 feet 4 inches, and the length of the drum is 2 feet 6 inches. The volume contained between the drum and outer edge of the blades is 27.3 cubic feet. If there were no leakage the meter would pass this amount per revolution. The clearance is from $\frac{1}{4}$ to $\frac{3}{8}$ of one inch. Under the conditions of small depth of water indicated in curve No. 1, the quantity passed was 28.75 cubic feet per revolution. Under conditions represented by curve No. 2, where the depth was greater, it was 30.4 cubic feet, and on the single test of maximum depth it was 33.0 cubic feet. These indicate slippages of 5.3, 11.4, and 20 per cent, respectively.

From these tests it would appear that a rating can be determined quite closely for any fixed condition under which the meter may operate. The accuracy obtained when using such a rating under such conditions of free fall or of unchecked ditch should be sufficient for any usual needs. When placed in ditches where variable submergence may be caused by checking up below, the rating will be subject to variations which may be as much as 10 to 15 per cent. The same effect might occur when installed in an unchecked ditch as shown in curve No. 2, due to natural checking during the season from weed growth in the ditch.

It would seem advisable where possible to install this meter as high in the ditch as conditions will permit, as under such settings the rating will be less liable to variation.

Where this is not practicable the rating should be chosen for the depth of submergence and the conditions in the ditch below kept as constant as possible.

The loss of head curves are also shown in the diagram. For the range of capacity of the meter the loss of head is quite small. The curve represents the head required to turn the meter; any raising of the meter in the ditch to prevent submergence would require additional fall. The three curves are plotted similarly to those for the rating of the meter. Less head seems to be required for the submerged condition.

SUMMARY OF EXPERIMENTS

Rate of discharge, cu. ft. per sec.	Total number of cubic feet passing the meter	Number of revolutions of meter	Cubic feet passing the meter per revolution	Loss of head through meter, feet	Depth of water in outlet, feet
<i>Rating under unchecked ditch conditions (Curve No. 2)</i>					
0.25	407	11	37.0	.015	0.14
.66	708	22	32.4	.02	.19
.96	1906	62	30.7	.05	.40
1.28	908	30	30.3	.04	.30
1.68	1454	48	30.6	.05	.36
1.99	726	24	30.3	.07	.35
2.46	874	29	30.2	.08	.46
2.94	1291	43	30.0	.09	.51
3.38	1900	62	30.6	.15	.56
4.26	1857	59	31.5	.23	.62
5.29	1732	54	32.0	.31	.88

*Rating for meter set high in ditch with excess fall below outlet sill of meter
(Curve No. 1)*

.51	911	30	30.4	.04	.12
1.04	1532	53	28.9	.07	.17
1.45	1688	59	28.6	.09	.20
1.95	2891	102	28.3	.10	.25
2.05	2113	74	28.55	.09	.28
3.57	1318	45	29.3	.23	.32
4.05	575	20	28.8	.32	.35

Rating with variable depth of submergence

2.16	1069	35	30.5	.15	.45
2.37	945	30	31.5	.11	.77
2.33	942	29	32.5	.13	1.01
2.25	990	30	33.0	.14	1.20

VII. GRANT-MICHELL METER. (Figures 21 and 22)

The tests of this meter are summarized in the accompanying table. Quantities varying from 0.5 to 6.5 cubic feet per second were run through the meter, the depth of water in the outlet being varied by checks. No regular variation of the discharge per revolution was apparent when discharging under varying submergence. The dial attached to this meter is graduated to read to 0.01 acre-inch. One-hundredth of an acre-inch equals 36.4 cubic feet. The meter was set up and several counts of the number of revolutions required to equal 0.1 acre-inch on the dial made. These showed 68 revolutions for 0.1 acre-inch, indicating that the dial is graduated to pass 5.35 cubic feet per revolution of the meter. The mean values found from the tests for discharges over 2 cubic feet per second was 6.10 cubic feet per revolution. For the size of meter used and the conditions of operation encountered, the gearing of the dial needs rearrangement. The box and setting were built according to the patentee's plans.

A total of 30 single runs were used in plotting the rating curve. It was found that a horizontal straight line fitted the points having discharge over 2 cubic feet per second as well as any curve. The average variation of the 24 tests at discharges over 2 cubic feet per second was 2.3 per cent. The same quantities were run through the meter, with checks varying from 0 to 12 inches high set in the outlet flume, without giving any apparent variation in the discharge per revolution. The quantities run with no checks gave somewhat more variable results, due apparently to the rougher water and more dis-

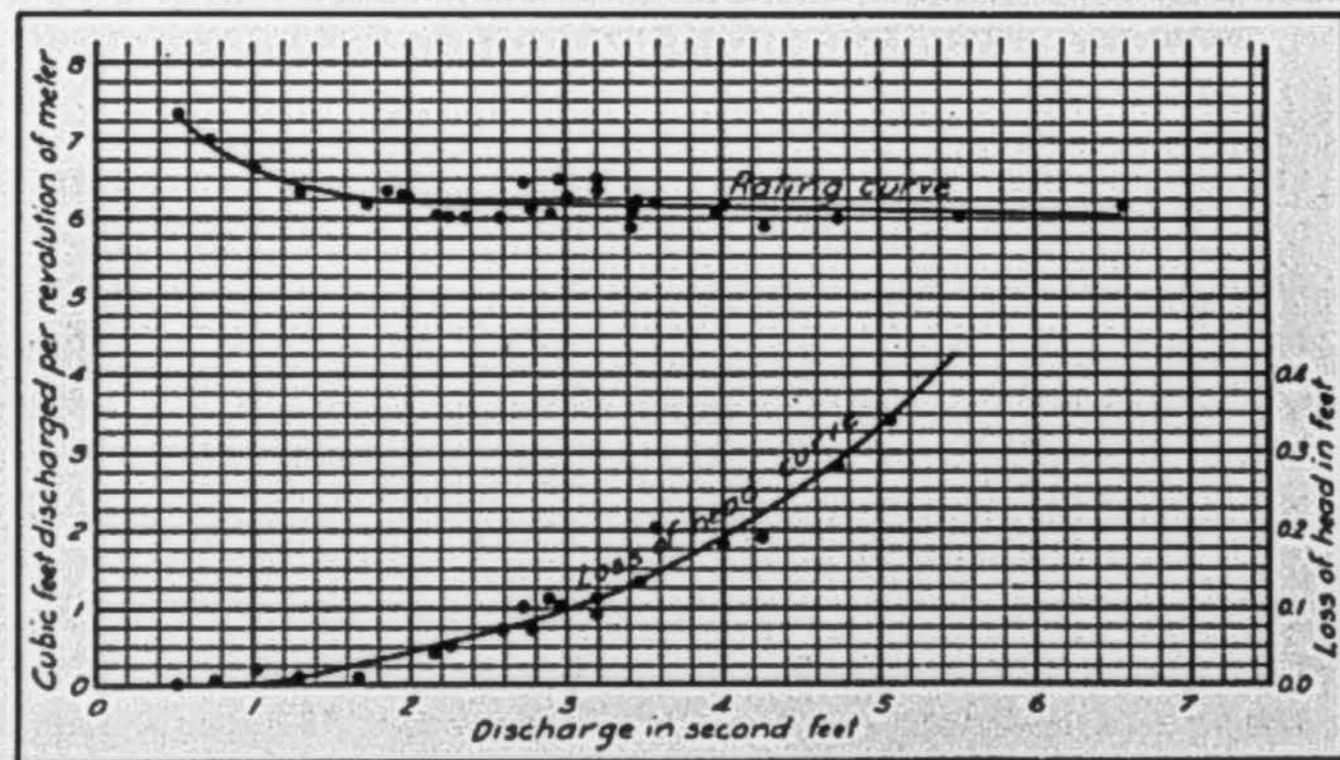

Rating Curve for Grant Michell Meter

turbed conditions. This constancy of discharge is probably due to the fact that the meter is set below the bottom of the outlet ditch, and is always submerged to a considerable depth. The rating curve rises at lower heads, as is to be expected.

The loss of head curve was also plotted from the readings of gages above and below the meter. The points obtained from tests where no checks were used were omitted on this curve as the loss of head in such cases would depend on the location of the gage. The outlet flume was not long enough for the water to become settled before reaching the spillway.

SUMMARY OF EXPERIMENTS

Actual mean discharge, cu. feet per-second	Number of 1-100 acre-inches recorded on dial	Total number of cubic feet passing meter	Cubic feet passing meter per 1-100 acre-inch recorded	Cubic feet passing meter per revolution of meter	Loss of head through meter, feet	Depth of water in outlet ditch, feet
.51	14.	694.7	49.6	7.30	0.00	0.84
.71	19.	903.4	47.5	6.99	.005	1.06
1.00	20.	901.3	45.1	6.64	.02	1.11
1.29	23.	987.0	42.8	6.30	.01	1.19
1.72	27.	1134.	42.0	6.18	.15	.53
1.85	16.	688.0	43.0	6.33	.13	.66
1.95	16.	685.9	42.85	6.30	.30	.38
2.16	13.	532.4	41.0	6.03	.04	1.30
2.24	36.	1468.	40.8	6.00	.05	1.30
2.35	14.	571.8	40.8	6.00	.06	1.31
2.57	19.	774.5	40.8	6.00	.07	1.34
2.72	22.5	983.	43.7	6.45	.10	.87
2.76	16.	665.6	41.6	6.12	.07	1.38
2.88	41.	1681.	41.0	6.03	.11	1.38
2.95	28.3	1239.	43.7	6.45	.10	1.06
3.00	51.3	2165.	42.2	6.21	.45	.28
3.18	24.	1032.	43.0	6.33	.09	1.26
3.19	43.4	1913.	44.0	6.47	.11	1.38
3.42	38.	1565.	41.2	6.06	.23	1.34
3.43	45.	1786.	39.7	5.86	.04	1.34
3.45	21.	884.	42.1	6.19	.13	1.42
3.56	30.4	1276.	42.0	6.18	.20	.95
3.95	28.8	1185.	41.2	6.06	.46	1.27
4.00	80.5	3361.	41.9	6.16	.18	1.18
4.27	20.	799.1	40.0	5.89	.19	1.53
4.74	105.	4263.	40.6	5.91	.28	1.05
5.06	25.	1031.	41.25	6.07	.34	1.61
5.52	58.	2362.	40.7	5.99	.23	.98
6.57	66.	2762.	41.8	6.15

These tests indicate that this meter can be rated with sufficient accuracy for the usual requirements of irrigation work. A correctly calibrated dial reading in acre-feet is an advantage, as any user can see for himself the amount of water he has received. The removable meter and head reduces the number of meters required, which at the quoted price of these meters is quite an item. This meter is similar in type to the Hill meter, which has curved vanes instead of flat ones.

VIII. 12-INCH HILL METER. (Figures 23 and 24)

Tests were made of a 12-inch Hill meter. A 27-inch meter and box had previously been installed but the capacity of this size of meter was larger than the discharges available at the experimental plant. The opening for the 12-inch meter was set in the box previously built for the 27-inch meter. This probably affected the loss of head but should not affect the meter rating.

The meter as supplied was geared to a Veeder counter with a gear ratio of 1 to 90. As the last figure on the counter is intended to represent $\frac{1}{1000}$ of an acre-foot, each revolution of the meter is equivalent to .484 cubic foot of water.

Eleven tests were made with discharges varying from 0.21 to 3.34 cubic feet per second. In addition, six tests were made with discharges varying from 1.18 to 1.56 cubic feet per second, and with varying depths of submergence. These are all summarized in the accompanying table.

For discharges of from 1 to 3.5 cubic feet per second, the rating curve is a horizontal straight line. The 7 points used to locate this line give an average number of cubic feet passed, per $\frac{1}{1000}$ acre-foot on the counter, of 43.4, or 0.3 per cent less than recorded. In these seven tests the depth of water in the outlet was varied as it would be in an unchecked ditch, the depth depending on the rate of discharge. Points for discharges of less than 1 cubic foot per second were not included in this average as the rating curve rises for these lower discharges, more water passing the meter than is recorded.

The maximum capacity of this meter as set was 3.5 cubic feet per second. For this discharge the water rose to the counter when coming through the orifice. By using a longer shaft on the meter higher rates of discharge can be crowded through this meter but the use of a larger meter would be preferable.

The additional tests made with variable depths of submergence did not give as uniform results, the six tests averaging 3.2 per cent

more discharge than recorded. The average of the thirteen tests made with discharges over 1 cubic foot per second gave 1.3 per cent more water passed by the meter than recorded. Data regarding tests of this same meter made by the U. S. Reclamation Service at Boise, Idaho, have been furnished for comparison. A total of twenty-three tests made by the Reclamation Service averaged 2.5 per cent more water passed than was recorded. The discharges in these tests varied from 1.11 to 3.96 cubic feet per second.

The loss of head curve for different rates of discharge is also shown. It should be remembered that the box used is larger than the standard for this size of meter. This reduces the total loss of head somewhat, although the main loss should be in passing through the 12-inch opening. The loss of head reached a maximum of 0.5 foot for a discharge of 3.5 cubic feet per second. In the Boise experiments mentioned above the loss of head was 0.87 foot for the same discharge.

From these tests it would seem that this meter will measure and record the quantity of water passing with sufficient accuracy for irrigation needs when the size of meter is chosen to fit the rates of flow to be received. The loss of head can be kept below that required for a weir by such selection of sizes. The opening in which the meter is set is 9 inches in height. This height is an advantage as the lines

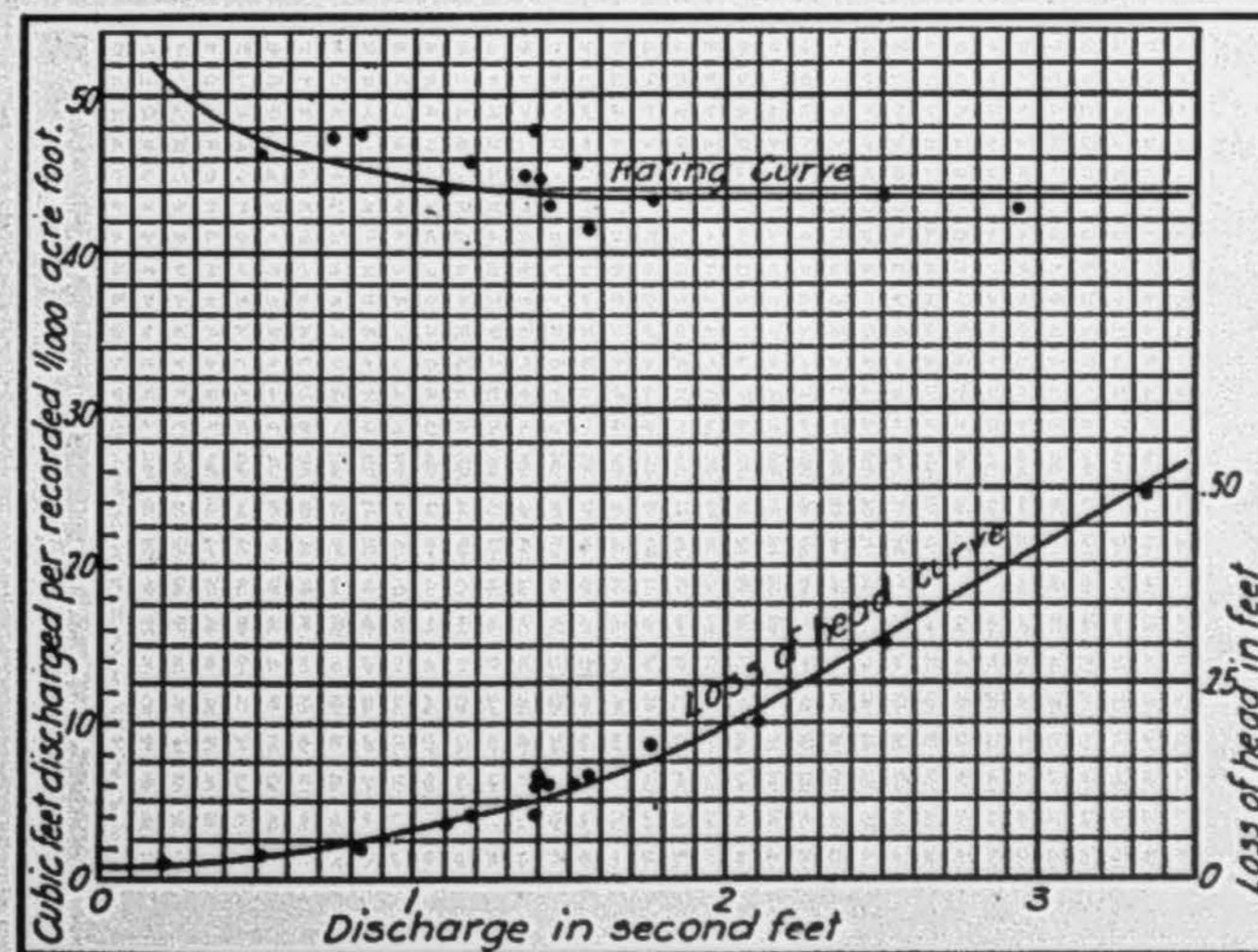

Rating Curve for Hill Meter

of flow are made straighter and more nearly parallel, giving more uniform action on the vanes of the meter. One disadvantage of the Hill meter is its limited range without changing the size of opening, but this does not seem to be difficult to overcome.

SUMMARY OF EXPERIMENTS

Discharge, cubic feet per second	Length of run, seconds	Total cubic feet passing meter	Thou- sandths acre- feet on counter	Cubic feet passed per 1/1000 acre-foot on counter	Loss of head, feet	Depth of water in outlet, feet	Variation of actual from recorded discharges, cubic feet per second
.83	480	394	8.3	47.5	.04	.68
1.10	1231	1361	31.	43.9	.07	.74	+ .34
1.43	990	1418	33.	43.0	.12	.78	— .56
1.77	974	1742	40.	43.2	.17	.80	— .36
2.10	460	967	22.	43.9	.20	.77	+ .34
2.51	398	999	23.	43.4	.30	.83	— .16
2.93	380	1113	26.	42.8	.41	.64	— .76
3.34	342	1141	26.	43.9	.49	.74	+ .34
.74	1084	804	17.	47.3	.04	.57
.52	1170	602	13.	46.3	.03	.35
.21	1974	408	8.	51.0	.02	.12
1.56	400	623	15.	41.5	.13	.34	—2.06
1.52	390	592	13.	45.6	.12	.68	+2.04
1.38	658	908	19.	47.8	.08	1.08	+4.24
1.40	288	401	9.	44.5	.12	.72	+ .94
1.40	447	624	14.	44.6	.13	.37	+1.04
1.18	542	642	14.	45.8	.08	.67	+2.24

Mean of all discharges over 1 cubic foot per second, cu. ft. per sec..... + .58

Mean in per cent 1.3

STATION PUBLICATIONS AVAILABLE FOR DISTRIBUTION

REPORTS

1897. Resistant Vines, their Selection, Adaptation, and Grafting. Appendix to Viticultural Report for 1896.
 1902. Report of the Agricultural Experiment Station for 1898-1901.
 1903. Report of the Agricultural Experiment Station for 1901-03.
 1904. Twenty-second Report of the Agricultural Experiment Station for 1903-04.
 1914. Report of the College of Agriculture and the Agricultural Experiment Station, July, 1913-June, 1914.

BULLETINS

- | | |
|--|---|
| No. | No. |
| 116. The California Vine Hopper. | 208. The Late Blight of Celery. |
| 168. Observations on Some Vine Diseases in Sonoma County. | 211. How to Increase the Yield of Wheat in California. |
| 169. Tolerance of the Sugar Beet for Alkali. | 212. California White Wheats. |
| 170. Studies in Grasshopper Control. | 213. The Principles of Wine-making. |
| 174. A New Wine-Cooling Machine. | 215. The House Fly in its Relation to Public Health. |
| 177. A New Method of Making Dry Red Wine. | 216. A Progress Report upon Soil and Climatic Factors Influencing the Composition of Wheat. |
| 178. Mosquito Control. | 224. The Production of the Lima Bean. |
| 182. Analysis of Paris Green and Lead Arsenate. Proposed Insecticide Law. | 225. Tolerance of Eucalyptus for Alkali. |
| 183. The California Tussock-moth. | 227. Grape Vinegar. |
| 184. Report of the Plant Pathologist to July 1, 1906. | 230. Enological Investigations. |
| 185. Report of Progress in Cereal Investigations. | 234. Red Spiders and Mites of Citrus Trees. |
| 186. Oidium of the Vine. | 240. Commercial Fertilizers. |
| 195. The California Grape Root-worm. | 241. Vine Pruning in California. Part I. |
| 197. Grape Culture in California; Improved Methods of Wine-making; Yeast from California Grapes. | 242. Humus in California Soils. |
| 198. The Grape Leaf-Hopper. | 243. The Intradermal Test for Tuberculosis in Cattle and Hogs. |
| 203. Report of the Plant Pathologist to July 1, 1909. | 244. Utilization of Waste Oranges. |
| 207. The Control of the Argentine Ant. | 245. Commercial Fertilizers. |
| | 246. Vine Pruning in California, Part II. |
| | 247. Irrigation and Measuring Devices. |

CIRCULARS

- | | |
|--|--|
| No. | No. |
| 46. Suggestions for Garden Work in California Schools. | 106. Directions for using Anti-Hog-Cholera Serum. |
| 62. The School Garden in the Course of Study. | 107. Spraying Walnut Trees for Blight and Aphis Control. |
| 65. The California Insecticide Law. | 108. Grape Juice. |
| 68. The Prevention of Hog Cholera. | 109. Community or Local Extension Work by the High School Agricultural Department. |
| 69. The Extermination of Morning-Glory. | 110. Green Manuring in California. |
| 70. Observation of the Status of Corn Growing in California. | 111. The Use of Lime and Gypsum on California Soils. |
| 75. A New Leakage Gauge. | 112. The County Farm Adviser. |
| 76. Hot Room Callusing. | 113. Announcement of Correspondence Courses in Agriculture |
| 79. List of Insecticide Dealers. | 114. Increasing the Duty of Water. |
| 80. Boys' and Girls' Clubs. | 115. Grafting Vinifera Vineyards. |
| 82. The Common Ground Squirrels of California. | 116. Silk Worm Experiments. |
| 83. Potato Growing Clubs. | 117. The Selection and Cost of a Small Pumping Plant. |
| 84. Mushrooms and Toadstools. | 118. The County Farm Bureau. |
| 87. Alfalfa. | 119. Winery Directions. |
| 88. Advantages to the Breeder in Testing his Pure-Bred Cows for the Register of Merit. | 120. Potato Growing in the San Joaquin and Sacramento Deltas of California. |
| 91. Disinfection on the Farm. | 121. Some Things the Prospective Settler Should Know. |
| 92. Infectious Abortion and Sterility in Cows. | 122. The Management of Strawberry Soils in Pajaro Valley. |
| 98. Plowing and Cultivating Soils in California. | 123. Fundamental Principles of Co-operation in Agriculture. |
| 100. Pruning Frosted Citrus Trees. | |
| 101. Codling Moth Control in the Sacramento Valley. | |
| 102. The Woolly Aphis. | |

Final Summary of Santa Fe Ranch Lands 1

Cleared Lands	3821	Acres
Eucalyptus Trees	1522	"
Uncleared Lands	<u>3056</u>	"
Total Area Ranch	8399	Acres

Of this the following can be irrigated from the present distribution line by the construction of the necessary laterals

Area A1 & A2

Cleared Lands	100	Acres now supplied by pumping
Uncleared "	<u>159</u>	"
	74	"
Total Area A1 & A2	333	Acres which can be supplied from line "A"

Area B includes that part of Walnut grove South of Little San Elijo

Cleared Lands	529	Acres
Eucalyptus Trees	141	"
Uncleared Lands	<u>240</u>	"
Total Area B	910	Acres which can be supplied from line "B"

Area C

Cleared Lands	96	Acres
Eucalyptus Trees	440	"
Uncleared Lands	<u>71</u>	"
Total Area C	607	Acres which can be supplied from line "C"

Note Line "C" extends to the Western boundary of the Ranch

FINAL SUMMARY OF SANTA FE RANCH LANDS

Cleared Lands		3821 Acres
Eucalyptus Trees		1522 "
Uncleared Lands in original grant	3056 Acres	
" " outside " "	<u>399 "</u>	
	3455 Acres	
Total Area Ranch		<u>8798 Acres</u>

Of this the following can be irrigated from the present distribution line by the construction of the necessary laterals.

Area A1 & A2		
Cleared Lands	100 Acres now supplied by pumping	
" "	159 "	
Uncleared "	74 "	
Total Area A1 & A2	<u>333 Acres</u> which can be supplied from Line "A".	

Area B includes that part of Walnut grove South of Little San Elijo.

Cleared Lands	529 Acres
Eucalyptus Trees	141 "
Uncleared Lands	<u>240 "</u>
Total Area B	910 Acres which can be supplied from Line "B".

Area C

Cleared Lands	96 Acres
Eucalyptus Trees	440 "
Uncleared Lands	<u>71 " 71</u>
Total Area C	607 Acres which can be supplied from line "C".

Note Line "C" extends to the Western boundary of the Ranch.

Estimate of Cost on Pipe Line
to Walnut Grove July 8/1919
6

7300 ft 14" pipe including laying @ 50¢ } Total
Excavation for same $2.5 \times 3.5 \times 7 = 8.75 = \frac{1}{3}$ cu yd per foot } 100 } 7300 —
cost per cu yd @ 1.50 = 50¢ per foot

6000 ft 12" pipe including laying @ 42¢ } Total
Excavation for same $2.2 \times 3.2 = \frac{1}{4}$ cu yd per foot } 82 } 4920 —
cost per cu yd @ 1.00 = 40¢ per foot

700 ft 10" pipe @ 34¢ } Total
Excavation $\frac{1}{4}$ cu yd per foot 40¢ } 74¢ } 518
Value materials etc 350

Eng & Overhead 15%

13088
2000
15088

13088
15%
65440
13088
196320

Sta	Elev	Point of take off		
0+00	223.8	Point of take off		69
				<u>15</u>
5+00	223.3	Begin of Siphon A	↑	54
12+00	222.6	End "	A	
20+00	221.8	Begin "	B	
40+00	219.8			
60+00	217.8			
70+00	216.8	Begin Siphon B		
73+00	216.5	End "	B ↓	
80+00	214.8			
100+00	212.8			
120+00	210.8	Begin Siphon C		
133+00	209.5	End "	C	
140+00	208.8			

7300
6000
13300
14000
700

315
155
155

52
255
255

14000
7000
31000

5) 2755

14000
7000
51800

7300
36500

1
2
3
4
5
6
7
8
9
10
11
12
13
14
15
16
17
18
19
20
21
22
23
24
25
26
27
28
29
30
31
32
33
34
35
36
37
38
39
40
41
42
43
44
45
46
47
48
49
50
51
52
53
54
55
56
57
58
59
60
61
62
63
64
65
66
67
68
69
70
71
72
73
74
75
76
77
78
79
80
81
82
83
84
85
86
87
88
89
90
91
92
93
94
95
96
97
98
99
100

Row	Pipe 14"	Pipe 12"	Pipe 10"	Pipe 6"
180				
4742				
166				
716	7400			
326				
15				
1505				
105				
705				
2085				
1285				
422				
44				
54				
65				
90				
32				
1233				

1100
1200
1000
1300
500
500
1400
1000
1000
1000

6400

721
 512
 1233

Estimate of Cost on Pipe Line to Walnut Grove

Pipe Size	Quantity	Unit Price	Total Cost
14" pipe	7400	50¢	3700.00
12" "	6200	42¢	2604.00
10" "	6400	34¢	2176.00
8" "		27¢	
6" "		20¢	
Total Area irrigated			640 Acres

Revised
 7300 ft 14" @ 50¢ = 3650.00
 Exc. $2\frac{1}{2} \times 2\frac{1}{2} \text{ ft} = 6\frac{1}{4} \text{ cu ft per foot} = \frac{3}{4} \text{ cu yd per foot}$
 @ 75¢ per yd = 250.00
 Cost including intake box manufacture 250.00

7400	7300	13300
	6200	7300
	13500	6000
		82
		6000
		4920.00
14000		
13300		
700		

Chapter 11

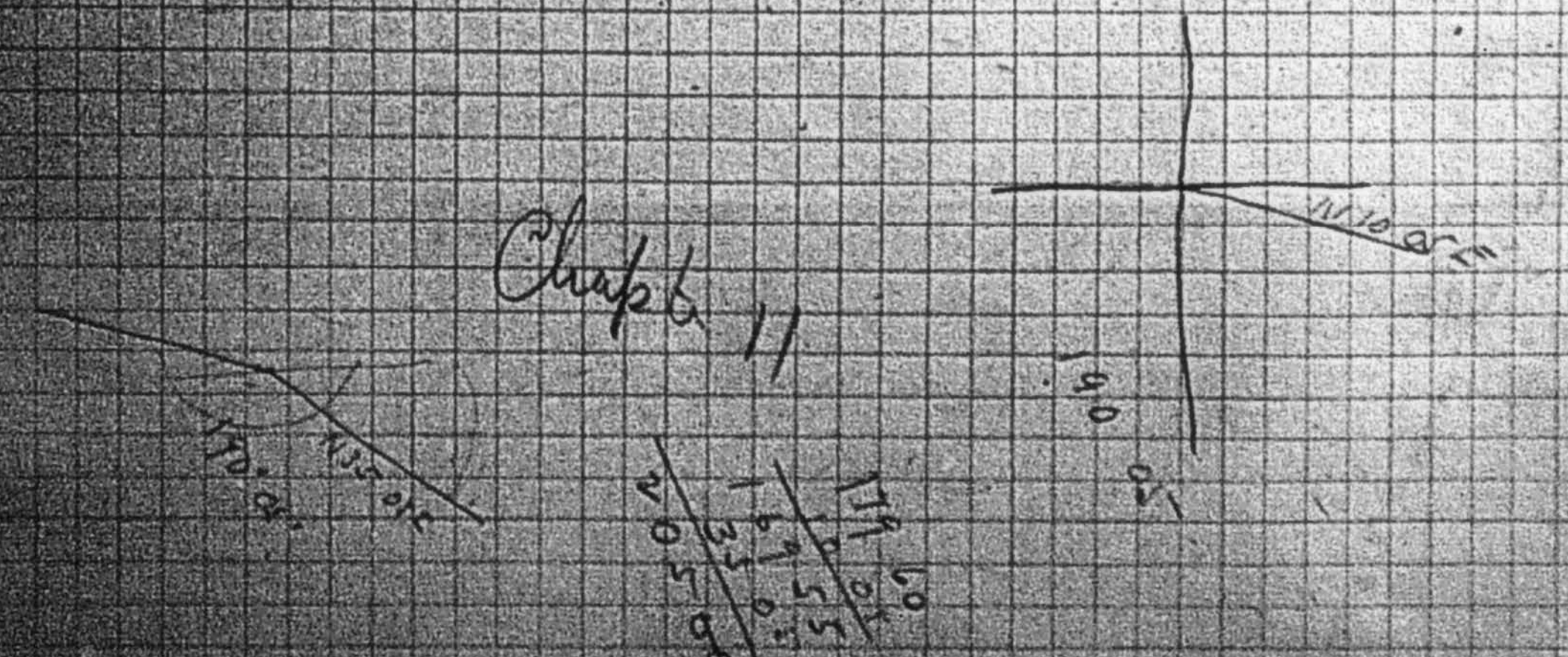

14" pipe	7400	@
12" "	6200	@
10" "	6400	@
6"	<u>17600</u>	@

6"	38900	@
----	-------	---

Ditch ABC	12000	
T	<u>5300</u>	
	17300	@ 25
	4325	

4500.00

32
90
60
9
6
20
205
422

180
66
97
175
21
76
32
11
155
27
19
12
821

76
78
154

Area	Capacity MI	Length of Pipe feet	Size	Grade	Cost per Foot Laid
J 1	72+	7400	14"	0.8	
J 4	47+	3400	12"	0.8	
J 5	37+	2800	12"	0.5	
J 8	28+	6400	10"	0.8	
J 11	5+	1400	6"	0.5	
J 2		1100	6"	0.5	
J 3		1200	6"	0.5	
J 6		1000 ^x	6"	0.5	
J 7		1300 ^x	6"	0.5	
J 9		500 ^x	6"	0.5	
J 10		500 ^x	6"	0.5	
J 12		1000 ^x	6"	0.5	
J 13		1000 ^x	6"	0.5	
J 14		1000 ^x	6"	0.5	
J 4 Lat		2200	6"	0.5	
J 8 Lat		2300	6"	0.5	
J 11 Lat		3109			
		<u>17600</u>			

6

Computation of size of pipe necessary to
 irrigate various portions of Santa Fe Ranch
 Duty of Water taken as 1 acre foot per acre per
 year to be delivered during Summer season of
 Six months
 Capacity of pipe calculated in Mins. Inches where
 50 MI = 1 Sec. L.

Temporary Ditch Lines
from San Dieguito Dam

Area	Acres served	length Pipe	Size	Cost	Remark
A	76.0	7200			
B	21.0	3000			
C	28.0	1800			
	<u>125.0</u>	<u>12000</u>			
T	78	5300			

Laterals from Distribution Line

Area	Acres Served	length Pipe	Size Pipe	Cost	Remarks
K	205	9100			Lateral Lines
L	8	1100			
M	12	1300			
N	2				
O	4	900			
P	4	800			
Q	5	700			
R	60	2500			
S-1	90	5200			
S-2	32	3400			
H	66	5000			
G	47	4800			
F	4	700			
E	2	700			
D	180	2700			
Totals	721	38900			

6" PIPE

J LINE						
Area	Acres Served	Length Pipe	Size Pipe	Minors Inchs necessary for Each Area		Remarks
J-14	7.0	1000	6"	1	1	Lateral
J-13	10.0	1000		2	1	Main
J-12	5.0	1000	6"	3	1	Lateral
J-11	17.0	1400		5	2	Main
J-10	2.0	500	6"	5.5	5	Lateral
J-9	1.0	500	6"	6.0	5	Lateral
J-8	155.0	6400		28	22	Main
		2300	6"			Lateral
J-7	6.0	1300	6"	29	1	Lateral
J-6	5.0	1000	6"	30	1	Lateral
J-5	32.0	2800		34	4	Main
J-4	76.0	3400		45	11	Main
		2200	6"			Laterals
J-3	8.0	1200	6"	46	1	Lateral
J-2	13.0	1100	6"	47	1	Lateral
J-1	175.0	7400		72	25	Main
		3100	6"			Lateral
Totals	512.0	37600ft				

22400ft Main
15200ft Lateral lines

14" - 7400 ✓ @ 200 14800
 12" - 6200 ✓ @ 150 9300
 10" - 6400 ✓ @ 122 7680
 6" - 17600
37600
 6" - 38700
00
 17600
 38900
56500 @ 150 36725
65
 282500
 339000
36725.00
 6200
3100
 9300
 6400
128000
 6400
7680.00

9/10/7

1470

814 + NW1

S 27

T12SR1E

Shank & Co.

N 1/4 SW

JDAQB Spudale

Primary 1/4
Crest 1/4
Inland

Ed

Final summary of Santa Fe Ranch Lands

Area "A" = 333 Acre practically all of which is good agricultural land

Using the duty of water at 0.8 per acre foot and figuring on delivering this amount of water during an 8 month irrigation period we find as follows

- 1 Acre ft per year = 0.0013813 Sec ft
- 1 Acre foot per 8 months = 0.0020719 Sec ft
- 333 Acre x 0.0020719 = 0.69 Sec ft required

Area "B" 910 Acre approx 80% of which will be susceptible of irrigation

910 x 0.8 x 0.0020719 = 1.51 Sec ft required

Area "C" 607 Acre of which also approx 80% will be susceptible of irrigation

607 x 0.8 x 0.0020719 = 1.01 Sec ft

Capacity Line A	10.69	Sec ft
Area "A" requires	<u>.69</u>	
Line B capacity	10.00	" "
	<u>9.62</u>	
	<u>.38</u>	Sec ft in spare
Capacity Line B	9.62	Sec ft
Area B requires	<u>1.51</u>	
Balance	8.11	
Area C requires	<u>1.01</u>	
	7.10	+ 35 = 7.48' fixed

3 column

Cost of pump

7 mil

San Diego

Pipe 4

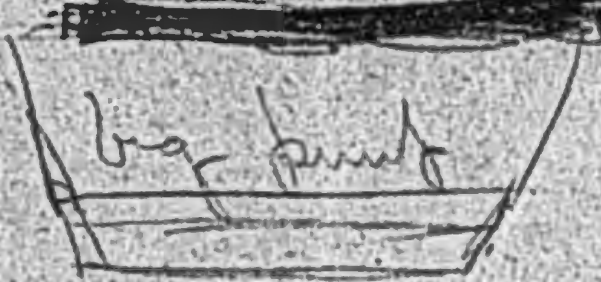

Letter to H. H. H. H.

ROM

Risk & Pipe line

Summary

Total Area within SF Rh 8399.00
 Divided at present as follows

Cleared Land	3821
Planted to Eucalyptus	1522
Uncleared Land	2953
Reservoir	103
	<hr/>
	8399

Total lands below normal development present Main Pipeline

10.69 Sec Jr -

72396698	5
<hr/> 10.69	7
651570282	31
434380188	
<hr/> 723966980	
77392070162	Ac Jr

	441
.0013813	<hr/>
6100000	
55252	
<hr/> 57480	
55252	
<hr/> 2280	

	318
.0013813	<hr/>
4400000	
41439	
<hr/> 45610	
13813	
<hr/> 117970	
110504	
<hr/> 64660	

33.3

33	MI H S F 3
<hr/> 50	
50	333
	66

2708 ✓ - 155.00 Relahuri
 500 ✓

64 MI	64
35	35
25	40
48	<hr/> 147
50	150
<hr/> 3.6	Sec feet
50	

76
 32
 108

6 56-A

LANDS IN RANCHO SAN DIEGUITO

	<u>North of River bottom</u>	<u>In and south of River bottom</u>
San Dieguito Reservoir site -----	150 acres	---
Above 300' contour -----	368 "	---
Between 300' and 250' contour -----	2021 "	5 acres
Between 250' and 40' contour -----	3802 "	810 "
Below 40' contour -----	<u>149</u> "	<u>1137</u> "
	6490 "	1952 "
Total in Rancho -----		8442 "

May 26, 1917

D.A.M.

Kellogg & Post show requirements below St. Ranch 6 ①
to be

250 Ac
480 " Pump
250
450

1430

Total on Lockwood Area

1. Area feet per acre per year =
.06906 MI per acre per year =
.0013813 Sec feet per acre per year

2564 Acres

6

~~2564~~ Ac ft per year
641

14.47 | 2564.00
~~21.77~~ 111
2
35.2

460 44
14

32
64

460
6
276.0

460 X .7
7.25
200

14.5
7.25

450 X

T

Duty of

6

Check me on this

.0013813 cu ft per second will give 1 acre ft per year

How many cu ft per second will be required
to deliver the same amount in 8 months
or $\frac{2}{3}$ of a year

$$.0013813 \times 1 = X \times \frac{2}{3}$$

$$\frac{2}{3} X = .0013813$$

$$X = \frac{3}{2} .0013813 = .0020719$$

.0013813
3
2 | 0041439
.0020719

6120200
 9175910
 15813
 27622
 12
 518100

6

I have provided for the irrigation of

333 ac
 910
 600
 1843

0004201
 09
 00005E
 09
 0485
 4984
 216
 243E

5181.1
 3217.4
 8398.5

3821.2
 1521.9
 3060
 31

53502
 0260
 8
 50E

25 25

005E - X X 0004815

000951E
 09
 009525
 09
 8760
 730
 1460
 24
 365

360
 60
 60

0004000
 518400
 60
 8640
 120
 1440
 24
 360

10018417
 0004604
 310013813 = 100 ft for pump

20736000
 345600
 60
 5760
 480
 960
 24
 240 change = 80m

28164466
 24132253
 37339669

6 (2)

Capacity of Pipe line leaving SD Pen = 10.69 Sec
 There will be drains from this line as follows

Area D = 180 ac
 " E = 2 ac
 " F = 4 ac
 " G = 47 ac
 " Pump = 100 ac
 333 ac which will require

333 ac ft for pump = .0013813 7 10.69
 333 0 146
 41439
 41439
 41439
 4599729 Sec ft

∴ There is left to go forward

However the Capacity of the long siphon known as line 2B is only

∴ there is available for further use of water for about .0013813 .6100000.

442 - ac

10.23

9.62 Sec
 .61 Sec

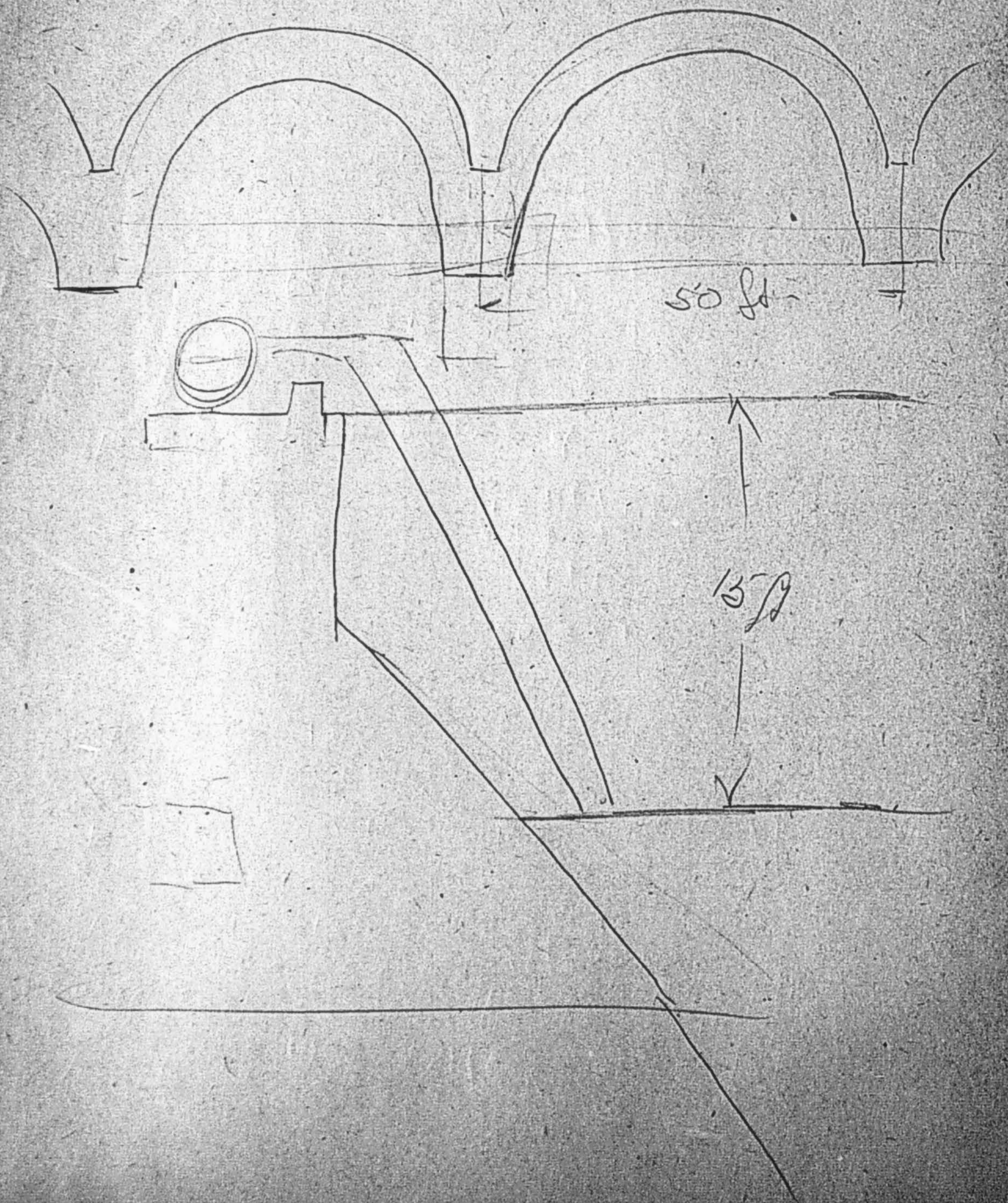

We have now available the capacity of
 the line 2B which is 9.62 Supt
 which must serve the following areas

Area 1 =	66	Ac
2-1 =	175	Ac
2-2 =	13	Ac
2-3 =	8	Ac
2-4 =	76	Ac
2-5 =	32	Ac
2-6 =	5	Ac
2-7 =	6	Ac
2-8 =	155	Ac
2-9 =	1	Ac
2-10 =	2	Ac
2-11 =	17	Ac
2-12 =	12	Ac
2-13 =	10	Ac
2-14 =	7	Ac
<hr/>		
S 1 =	585	Ac
S 2 =	90	Ac
S 3 =	32	Ac
<hr/>		
	203	Ac
<hr/>		
	910	Ac

910 Ac ft per year

.0013813	9
<hr/>	
138130	9
<hr/>	
124317	
<hr/>	
12569830	

9.62
 1.26

 8.36
 See H left to perform

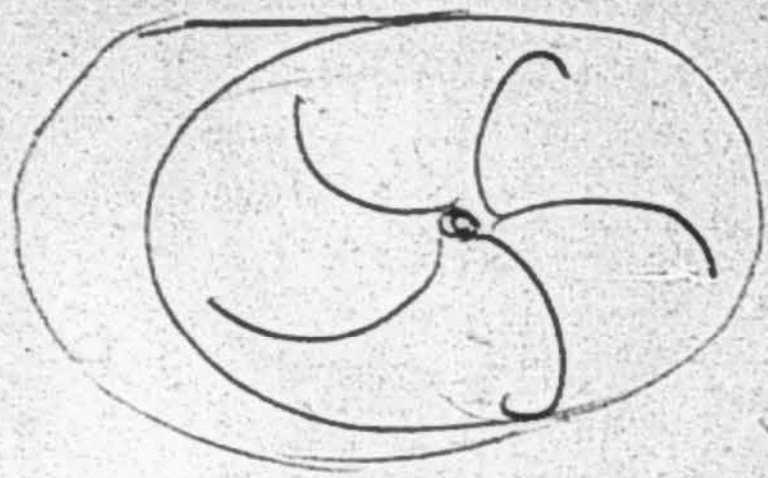
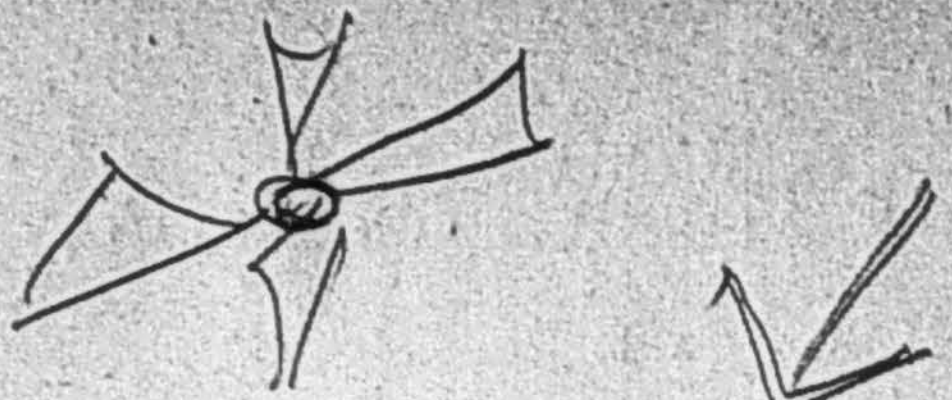

15 1/2%
10%

10

1/2

$$\begin{array}{r} 1.5 \\ \times 60 \\ \hline 420 \\ 90 \\ \hline 2700 \\ 3150 \end{array}$$

$$\begin{array}{r} 1.5 \\ \times 60 \\ \hline 450 \end{array}$$

5



6

4

Then in left part
to go forward while we have
a capacity of 8
the deficiency of
can be made up from the
from excess of .61 Sec ft in
the line 1A by slightly raising
the main water. Thus we may
figure on the full capacity of

	8.36 Sec ft
	8.54 Sec ft
	.18 Sec ft
	.61
	43 Primary Excess = 1A
	8.54 Sec ft

From this line there will be distribution

Area R	=	60 ac	}	
Q	=	5 ac		
P	=	4 ac		
O	=	4 ac		
N	=	2 ac		
M	=	12 ac		
L	=	8 ac		
K	=	205 ac		
		220 ac		
		520		should be 600 ac

520 ac per year @	.0013813		8.54
	520		.83
	.8287800	276260	
		69065	7.82
		.7182760 Sec ft	7.91

There is . . . 7.91 Sec ft available to go beyond the Ranch

Second Study

Capacity of pipe leaving San Diego in Penum is 10.69 Sec feet

The area outlined in red is dependent upon the first section of the line and comprises 230 ac. Added to this is an area outlined in blue of 100 ac. This is served by pumping.

This total of 333 ac will require 333 ac feet which will have to be delivered during an 8 month migration period.

This will require a delivery of

$$333 \times .0020719 \text{ Sec ft} =$$

$$\begin{array}{r} 333 \\ 62157 \\ 62157 \\ \hline 62157 \end{array}$$

.6899427 ✓ Sec ft necessary for Section A

From the lower end of Siphon which we will call Section B 910 ac must be served also outlined in red.

This will require $910 \times .0020719$

$$\begin{array}{r} 910 \\ 207190 \\ 186471 \\ \hline 1.8854290 \end{array}$$

1.8854290 ✓ Sec ft for Section B

From this point to the Ranch Boundary will require to serve 607 ac will require $607 \times .0020719$

$$\begin{array}{r} 607 \\ 145033 \\ 1243140 \\ \hline 1.2576433 \end{array}$$

1.2576433 ✓ Sec ft for Section C

Second Study

We start out from the San Diego in Penum with a carrying capacity of

Section A require
Balance
Section B require
Section C require
Balance

$$\begin{array}{r} 10.69 \text{ Sec ft} \\ \underline{.69} \\ 10.00 \\ \underline{1.89} \\ 8.11 \\ \underline{1.26} \\ 6.85 \end{array}$$

Total acreage which can be served by present pipe line 1850 ac

Quest. 1. How much of this is now cleared?

2. How much in Cicalyp.

3. How much not cleared.

While there is 7.87 Sec ft left after taking care of needs within the ranch. The capacity of the line is but 7.5 sec ft which leaves a balance of $\frac{7.87}{7.5}$

32 Sec ft margin of safety within the Ranch a margin for 1600 ac

The Requirements below the Santa Fe Ranch are as follows

City of San Diego	5 Sec ft
Provided for Del Mar	1 " "
	<hr/> 6 Sec ft

The capacity of the 24" line is 7.5 Sec ft then leaving 1.5 Sec ft available for

A 1 & 2

Cleared Land		Eucalyptus Trees		Uncleared Land		Total Acres
Plan. Ten Reading	Acres Reading	Plan. Ten Reading	Acres Reading	Plan. Ten Reading	Acres Reading	

Included
pump launch
100 ac

	0491 1256 <u>1747</u>	259.0 <u>163.0</u>	—	—	74.0 70.	333.0 Includ 100A Pump Land
--	-----------------------------	-----------------------	---	---	-------------	-----------------------------

B

	3575 0045 2055 <u>5725</u>	529.4 <u>534.1</u>	1373 0190 <u>1563</u>	140.8 <u>145.8</u>	239.8 <u>230.1</u>	910.0
--	-------------------------------------	-----------------------	-----------------------------	-----------------------	-----------------------	-------

C

	0450 0043 0083 0500 <u>1076</u>	96.4 <u>100.4</u>	4904 0043 <u>4861</u>	440.5 <u>453.5</u>	70.0 <u>61</u>	607.9
--	---	----------------------	-----------------------------	-----------------------	-------------------	-------

Total	8848 <u>7975</u> 7848 <u>2.7</u>		581.3 <u>598.3</u>		383.9 <u>306</u>	1850
-------	---	--	-----------------------	--	---------------------	------

383.9
306.2
78.6

Rumsey Plannets 0811 = 75.2 Acres

Description of Property	Total Acreage	Cleared Lands				Escalation Lands					Uncleared Lands				
		Total Acres	Plannets	Below Reading Water	Plannets Above Reading Water	Total Acres	Plannets	Below Reading Water	Plannets	Above Reading Water	Total Acres	Plannets	Below Reading Water	Plannets	Above Reading Water
SE 1/4 Sec 18	109.23	31.6	0.3	4.1						77.6					
NE 1/4 Sec 19	159.8	129.1	1.3	9.4						30.7					
NW 1/4 " 19	97.7	76.0	0.5	2.0						21.7					
SW 1/4 " 19	61.4	6.7	0.7	2.4						94.3					
SE 1/4 " 19	159.8	107.5	1.6	21.6	0.3	8.3				52.3					
NE 1/4 " 30	160.8	135.8	1.4	6.4	1.1	1.5	1.9	7.3	2.4	10.2	0.1	1.0	1.9	8.3	
NW 1/4 " 30	162.6	83.4	0.9	0.0	3.9	0.0	8.9	*		79.2				22.0	
SW 1/4 " 30	60.8	114.0	1.2	3.0	7.2	4.1	2.8	2		46.8		2.7	0.4	8.0	
SE 1/4 " 30	160.0	53.3	0.5	7.5	5.3	0.9	2.0		1.3	106.7		4.1	0.7	8.0	
SE 1/4 " 24	52.9	39.3	0.4	2.4	*					13.6					
NE 1/4 " 25	54.8	30.3	0.3	2.7	*					24.5					
SE 1/4 " 25	30.8	30.8			6.8	0.8	2.0	2.4							
NE 1/4 " 31	160.0									160.0					
NW 1/4 " 31	97.6									70.8	0.7	6.4	5.6	0.6	
SW 1/4 " 31	16.0									11.0					
SE 1/4 " 31	145.4									145.4					

99.9
3.48

103.46

160.8
62.1

98.7

160.8
63.6

97.2

15.8

1320.4
942.1

954.9

3217.4
34

Change

Run 103.5

88.2
33.2

21.9

3046.0
1521.7
3821.2

8388.9

2

124.5
103.5

21.0

3217.4
5181.9

8399.3

942.1
579.8

1521.9

954.9
2005.1

3058.0

3050
103

2947

Description of Property	Cleared Lands						Fucalyptus					Uncleared Lands				Yokaw Lands & Water		
	Total Acres	Total Acres	Plan Reading	Below Water	Plan Reading	Above Water	Total Acres	Plan Reading	Below Water	Plan Reading	Above Water	Total Acres	Plan Reading	Below Water	Plan Reading	Above Water		
SW 1/4 Sec 15	142.86	82.5	1460			92.5						60.4				60.4	*	
SE 1/4	159.21	70.8	1255			70.8						88.4				88.4	88.4 Lake?	
SW 1/4	187.21	154.0	2715	0302	0534	1570						33.2				15.8	+ 33.2 less lake area	Lake 17.4 ac. 0309
NW 1/4	159.16	144.8	2561	6.7	0119	1381						14.4				14.4	*	
NE 1/4	159.16	132.5	2343			132.5						26.7				26.7	*	
SU 1/4	159.29	30.9	0548	3.7	0065	272	23.2	0250	17.9	0140	15.3	105.2		39.5	0703	65.7		
SE 1/4	159.30	51.5	0911			51.5						107.8				107.8		
NW 1/4	157.90	73.0	1291			73.0						84.9				84.9		
SW 1/4	172.42	45.6	0806			45.6						126.8				126.8		
NW 1/4	160.25											160.3				160.3	*	
NE 1/4	27.33											27.3				27.3	*	
SW 1/4	159.17											159.2				159.2	*	
SE 1/4	42.28											42.3				42.3	*	
NW 1/4	160.52	62.1	1100	62.1			41.7	0450	1.6	0028	40.1	56.7		32.7	0579	56.7	*	
NE 1/4	160.53	46.0	0815	25.4	0449	20.6						114.5		47.6	0843	66.9		
SW 1/4	159.67	159.0	2835	79.0								7				7		
SE 1/4	159.67	92.1	1631									67.6				67.6		
NW 1/4	159.80	87.7	1552				6.0	0065				66.1				66.1		
NE 1/4	159.80	51.5	0913									108.3				108.3		
SW 1/4	159.87	154.0	2734									5.9				5.9		
SE 1/4	159.87	89.8	1591				48.5	0524				21.6				21.6		
NW 1/4	159.04	32.4	0574									127.0				127.0		
NE 1/4	47.39		0017									47.4				47.4		
SW 1/4	96.04	79.5	1409				8.3	0090				8.2				8.2		
NW 1/4	170.85	170.85																
NE 1/4	73.81	79.5	1409				4.3											
NW 1/4	104.1	8.1	0123									96.0				96.0	*	
NE 1/4	96.5	19.5	0346									77.0				77.0	*	
SW 1/4	163.6	81.8	0563									142.2				142.2	*	
SE 1/4	163.6	135.0	2329	3.6	0063	*						28.6				28.6		
NE 1/4	167.1	154.0	2734									13.1				13.1		
NW 1/4	163.8	90.3	1600	21.0	0372		29.0	0514	29.0			44.5		44.5		44.5		
SE 1/4	159.9	91.5	982	18.5	0327		35.7	0631	Tot	Tot	Tot	32.8				32.8		
SW 1/4	159.9	20.8	0368	20.8			139.2		273.5	294.5	143.4							
NE 1/4	159.9	70.1	1245	10.7	0190		83.4					6.0				6.0		
NW 1/4	159.9						16.0											
	5181.10	2500.8					579.8					2101.1						

2006.7
84.4
2091.1

5181.1
5175.7
5.4
6
.6

5181.10
5177.5
13.6

+ Reservoir ? 28.6

River Bottom
44.5

Ranch Home grounds 6 ac

6
SAN DIEGO, CALIFORNIA, July 7, 1919

Col. Ed Fletcher,
Office.

Dear Sir:-

To get water to the walnut grove by means of a
4" iron pipe will require about 10,000 lin.ft. of pipe.

A 4" pipe will deliver water at about 15 ft. higher
elevation than a ditch, but will only deliver 1/2 acre feet
per day or 12 $\frac{1}{2}$ Miners Inches continuous flow.

The cost of the pipe will be about ⁴⁵80¢ per foot
or about ⁴⁵⁰⁰\$6,000.

Yours respectfully,

THK:BK

6
SAN DIEGUITO - DEL MAR DISTRIBUTION LINES

Estimate of Discharge through Siphons

Siphons No.	Size	Grade	Estimated Dis. in Sec Ft
6 to 12	24"	-.0012	8.8
13 to 16	24"	-.001	8.0
17 to 18	24"	-.0009	7.5
19	24"	-.0008	7.0
20 to 24	24"	-.0006	5.8
25 to 33	20"	-.0007	4.0
34 to 36	20"	-.0006	3.7

computations by Mr. Green.

6

UNITED STATES DEPARTMENT OF AGRICULTURE
BUREAU OF PUBLIC ROADS

FEDERAL BUILDING
BERKELEY, CALIFORNIA

August 28, 1920.

Mr. T. H. King,
c/o The Ed Fletcher Co.,
920 - 8th St.,
San Diego, California.

Dear Sir:

Replying to your letter of August 24, we have no information on the soil survey of the San Diego area other than that contained in the published report of which you have a copy. However, before this report was printed, we obtained data from the manuscript maps in Professor Shaw's office and platted the principal soil types within the proposed irrigation district as then outlined. A blue print of this map is attached.

Yours truly,

Frank Adams

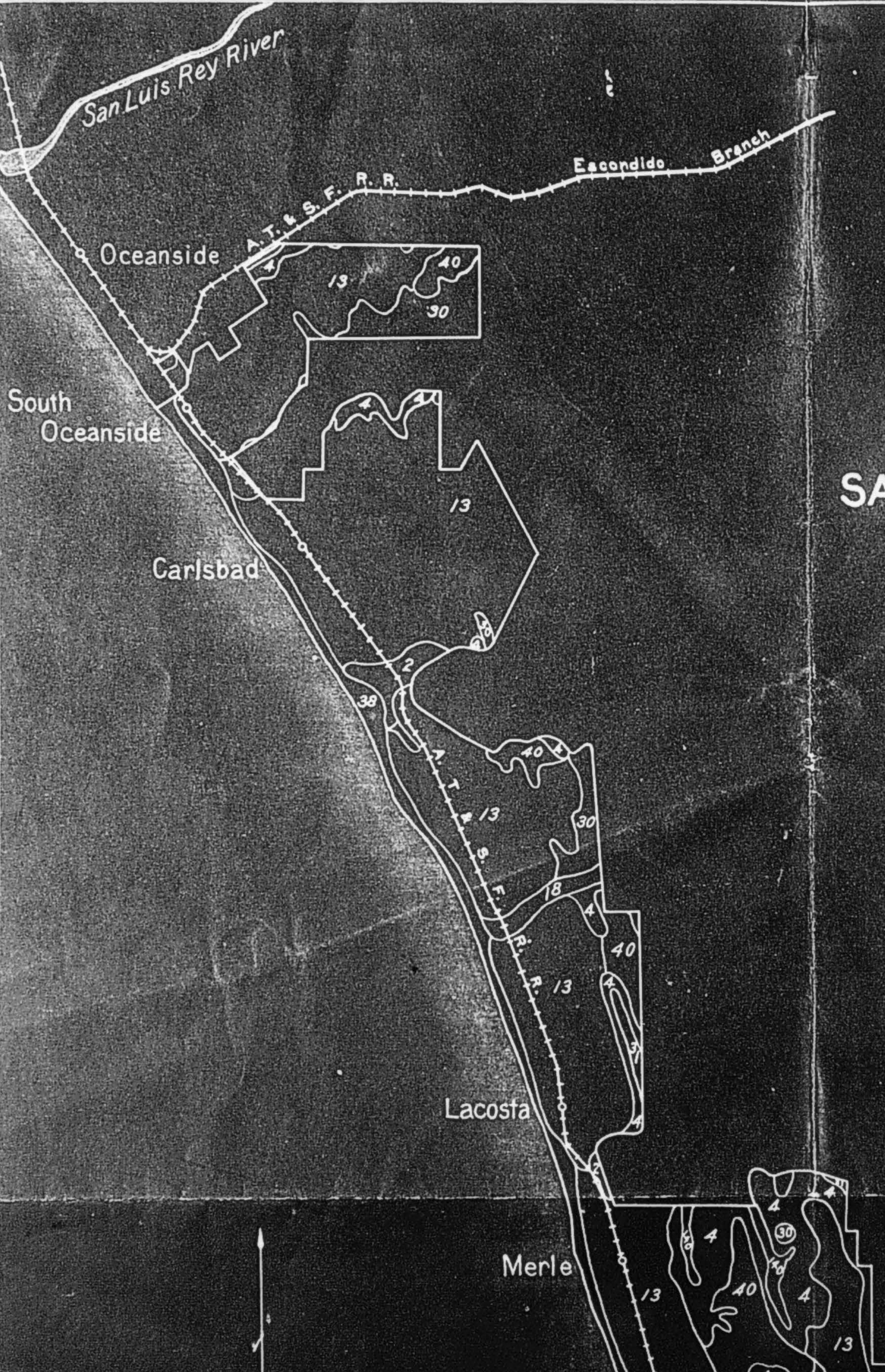

COOPERATIVE IRRIGATION INVESTIGATIONS
 IN CALIFORNIA
 SOIL MAP
 PROPOSED IRRIGATION DISTRICT
SAN DIEGO COUNTY, CAL.
 Del Mar to South Oceanside

Data from Unpublished Report
 Division of Soil Technology
 College of Agriculture
 University of California

BERKELEY, CAL.

JANUARY, 1918

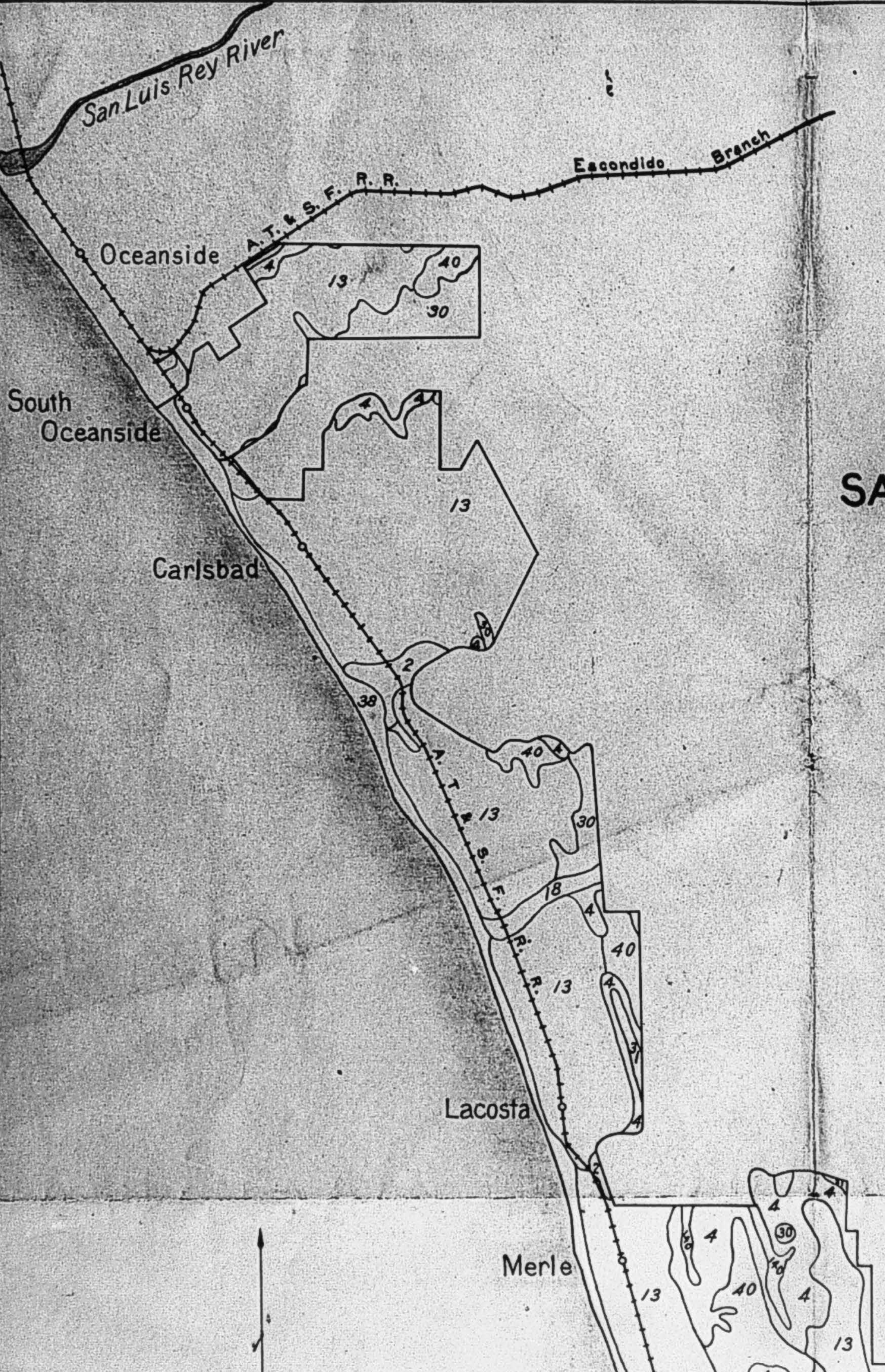

COOPERATIVE IRRIGATION INVESTIGATIONS
 IN CALIFORNIA
 SOIL MAP
 PROPOSED IRRIGATION DISTRICT
SAN DIEGO COUNTY, CAL.
 Del Mar to South Oceanside

Data from Unpublished Report
 Division of Soil Technology
 College of Agriculture
 University of California

BERKELEY, CAL.

JANUARY, 1918

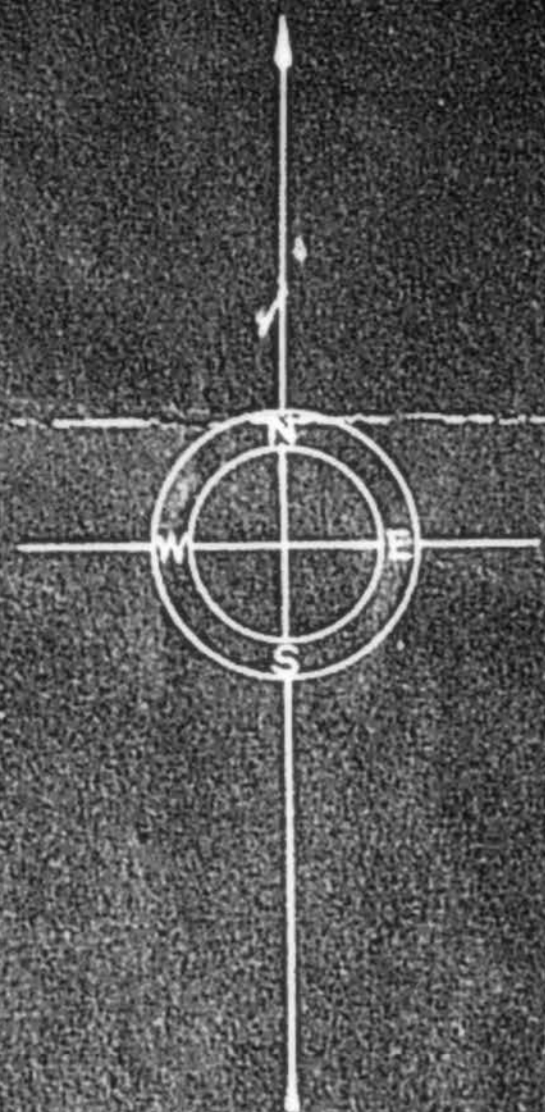

SOIL CLASSIFICATION

- 2 Tidal Marsh
- 4 Rough Broken Land
- 8 Olympic Loams
- 9 Rough Stony Land
- 13 Kimball Sandy Loams
- 15 Yolo Clay Loams
- 18 Hanford Sandy Loams
- 30 Montezuma Adobe Soils
- 31 Yolo Loams and Sandy Loams
- 38 Coastal Beach and Dune Sand
- 40 Los Flores and Kimball Loams and Sandy Loams Undifferentiated
- 43 San Joaquin Sandy Loams
- 44 Aiken Stony Loams
- 49 Hanford Fine Sandy Loams
- 140 Dublin Loams and Clay Loams

Merle

Encinitas

Cardiff

Olivenhain

San Dieguito River

Del Mar

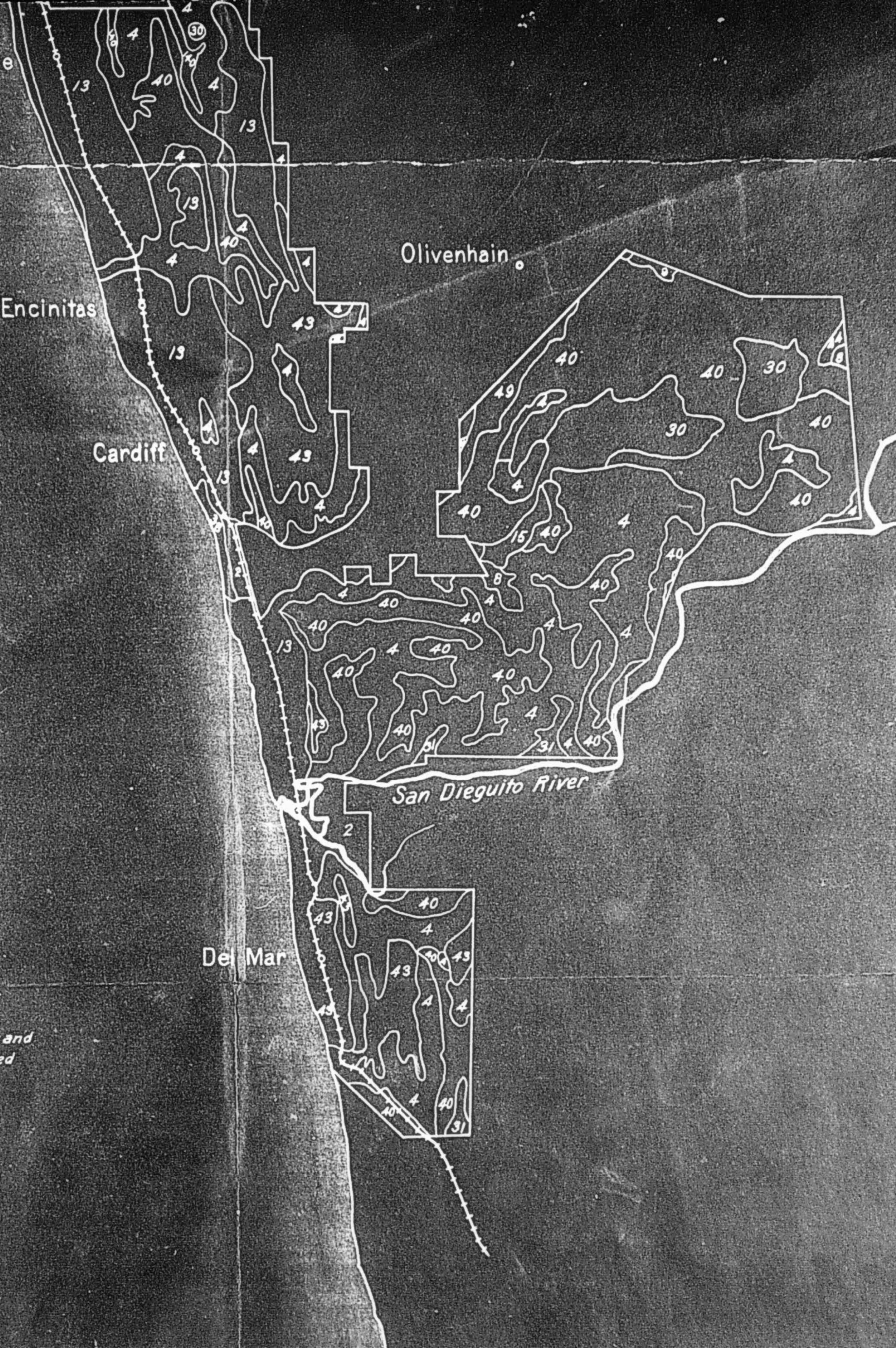

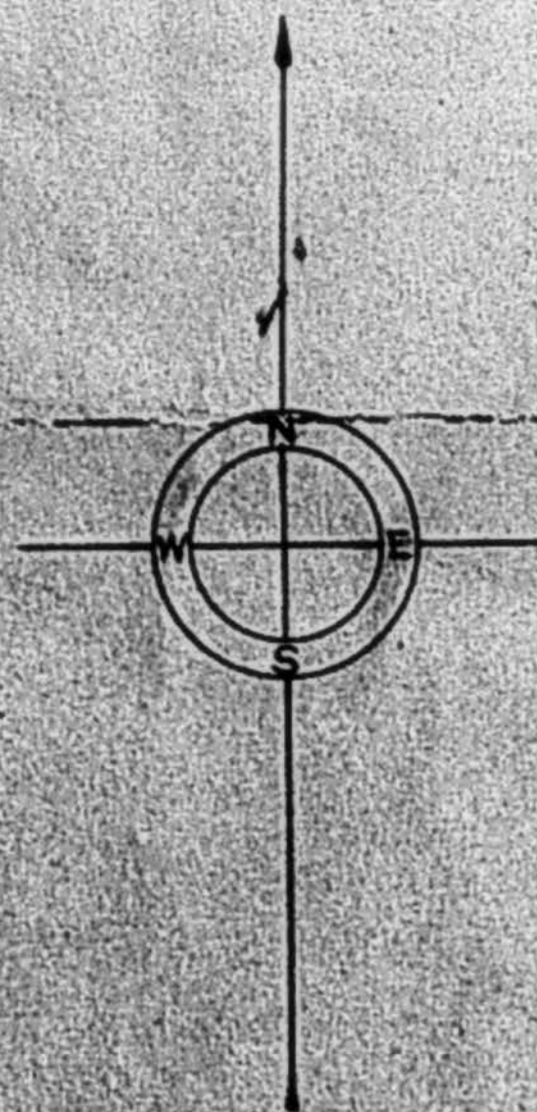

SOIL CLASSIFICATION

- 2 Tidal Marsh
- 4 Rough Broken Land
- 8 Olympic Loams
- 9 Rough Stony Land
- 13 Kimball Sandy Loams
- 15 Yolo Clay Loams
- 18 Hanford Sandy Loams
- 30 Montezuma Adobe Soils
- 31 Yolo Loams and Sandy Loams
- 38 Coastal Beach and Dune Sand
- 40 Los Flores and Kimball Loams and Sandy Loams Undifferentiated
- 43 San Joaquin Sandy Loams
- 44 Aiken Stony Loams
- 49 Hanford Fine Sandy Loams
- 140 Dublin Loams and Clay Loams

Merle

Encinitas

Cardiff

Olivenhain

San Dieguito River

De Mar

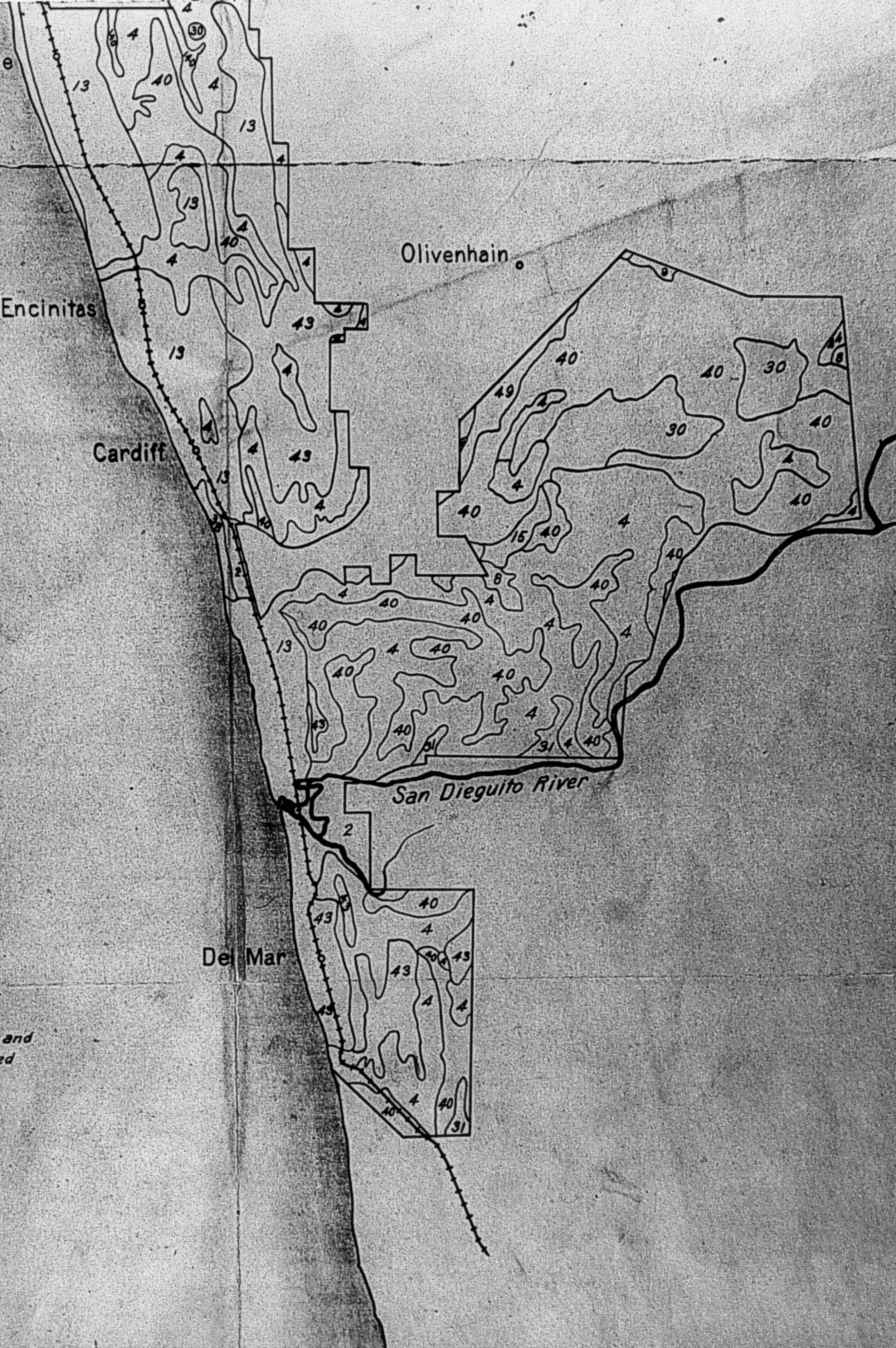

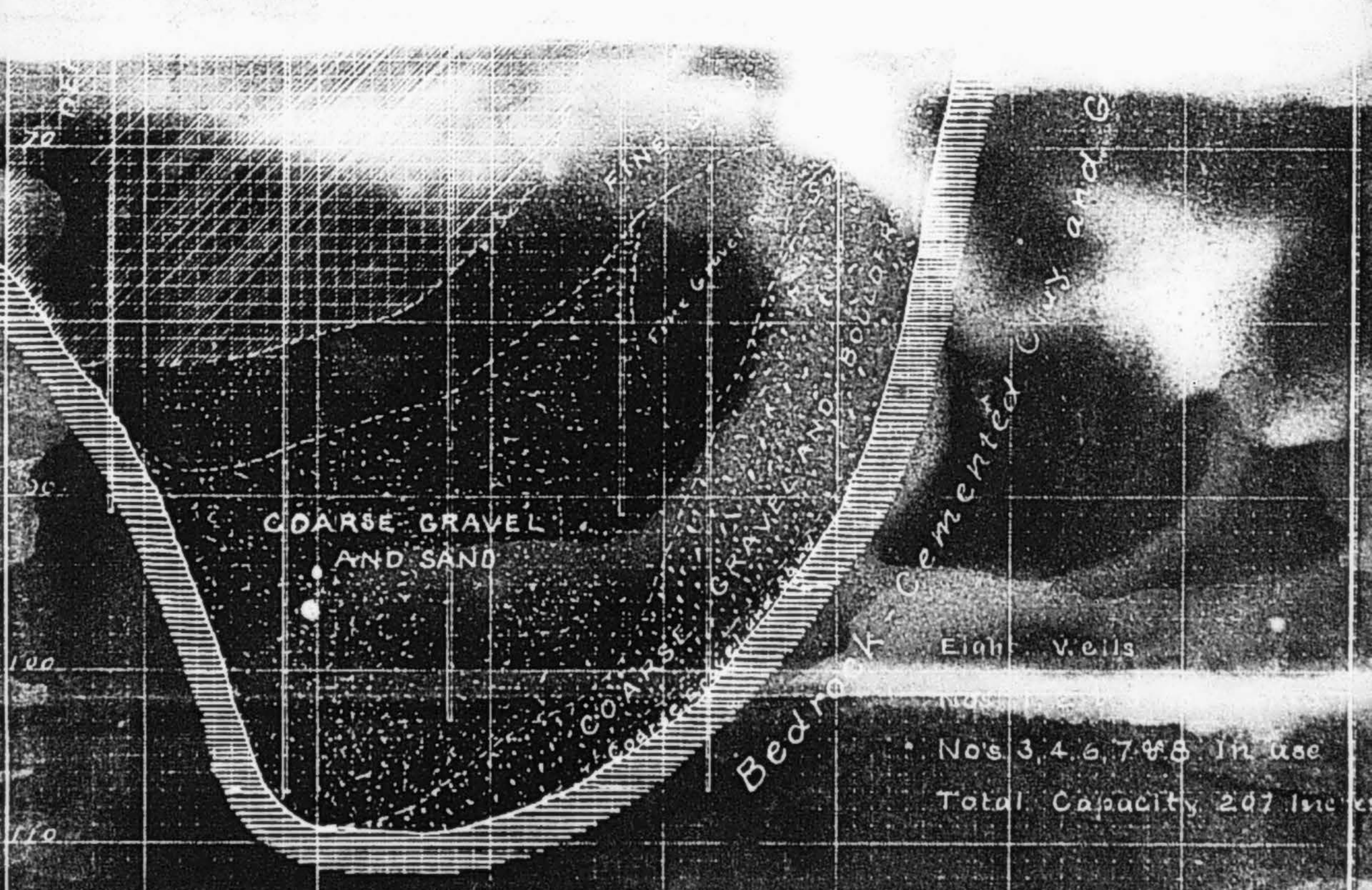
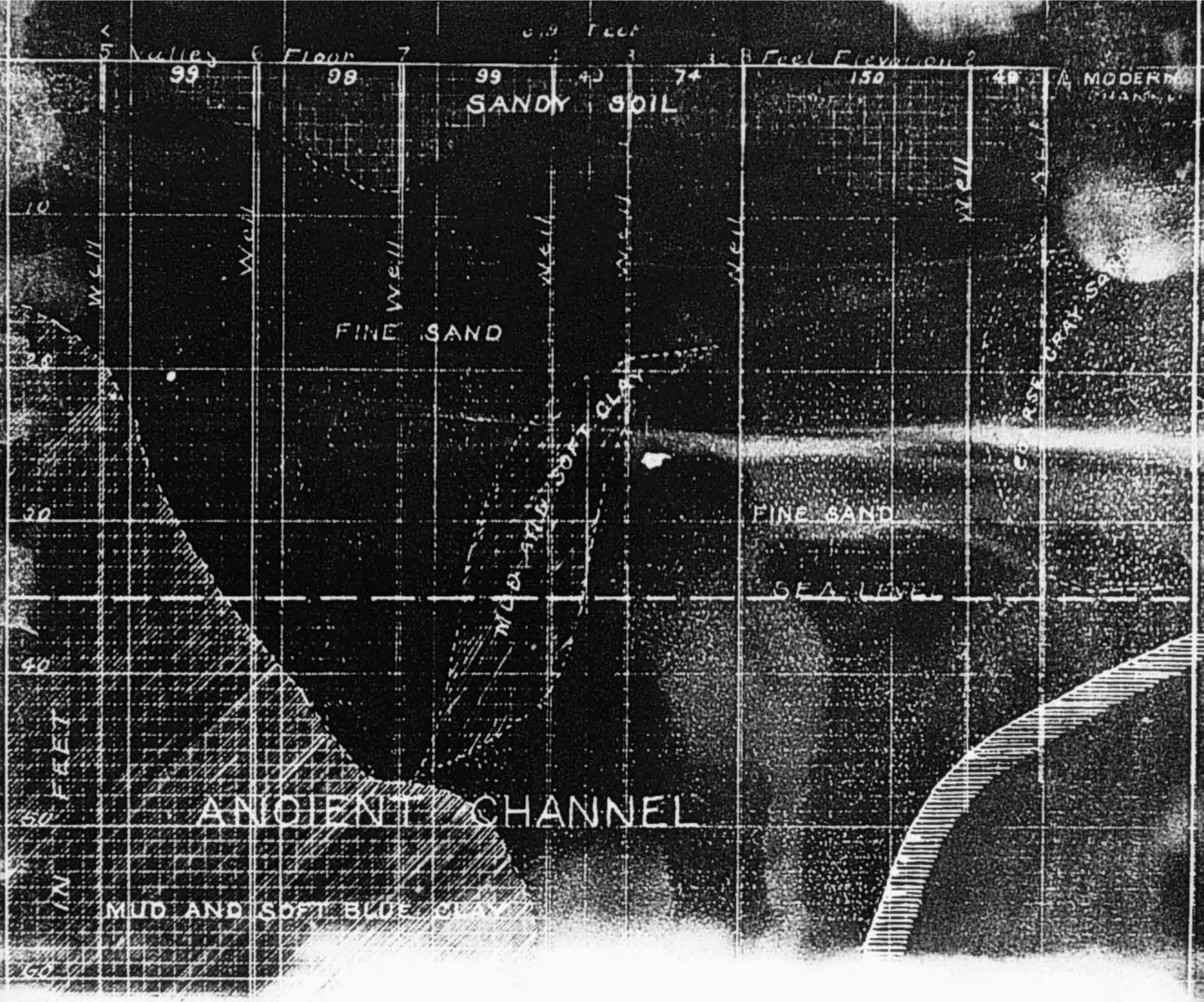

CROSS-SECTION OF SAN DIEGUITO VALLEY

IN LINE WITH SANTA FE LAND IMPROVEMENT CO'S WELLS AT PUMP STATION
 SAN DIEGUITO RANCH, DEL MAR, CALIF.

From Logs of the Wells

Horizontal Scale - 10 ft = 1 in

Vertical " " 10 "

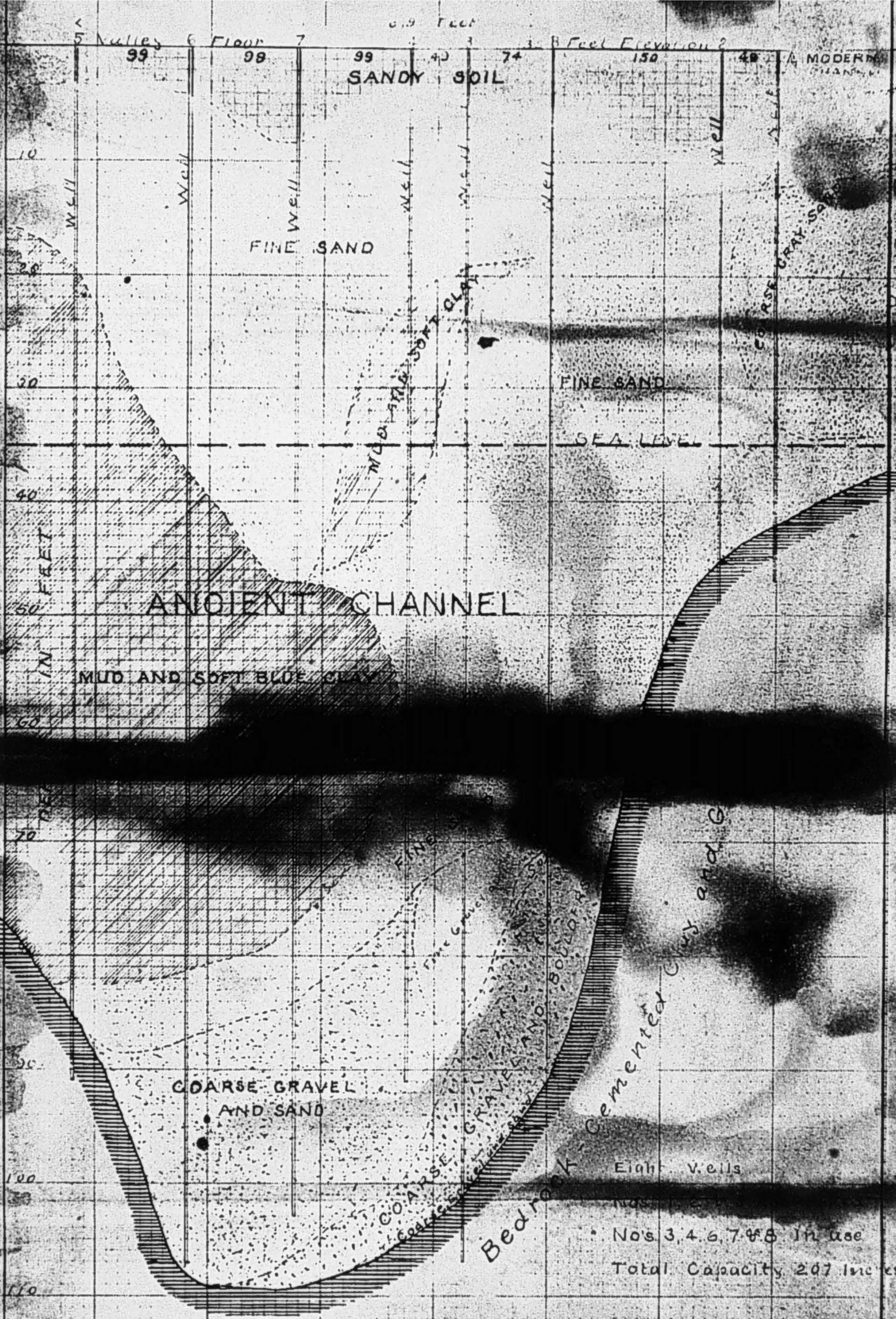

CROSS-SECTION OF SAN DIEGUITO VALLEY

IN LINE WITH SANTA FE LAND IMPROVEMENT CO'S WELLS AT PUMP STATION
 SAN DIEGUITO RANCH, DEL MAR, CALIF.

From Logs of the Wells

Horizontal Scale - 100 ft = 1 in

Vertical " 10 "

July 17, 1917

Log of Hyers Well No. "W"

Located on East boundary of Hyer property

Log obtained in 1913 - Casing well now destroyed.

- To 147 feet - Fine sediments.
- At 148' ± - 2 or 3 feet of boulders
- At 149' ± - Enter blue shale.
- At 176' - End of well in blue shale.

July 16, 1917.

Mr. King:

Enclosed find a log of the wells on the Santa Fe Ranch. What records have you in this respect?

Ed Fletcher.

F-S

2/5 133

DESCRIPTION OF THE EXTERIOR BOUNDARY OF THE PROPOSED
SANTA FE IRRIGATION DISTRICT.

Beginning at a point on the Range Line between Range 3 West and Range 4 West, S.B.M. formed by the intersection of the said Range line with the East and West center line of Section 1, Township 14 South, Range 4 West, S.B.M.:

1. Thence Westerly along the said East and West center line of said Section 1 to an intersection with the North and South center line of the Northeast $\frac{1}{4}$ of the Southwest $\frac{1}{4}$ of said Section 1:
2. Thence Southerly along the said North and South center line of the Northeast $\frac{1}{4}$ of the Southwest $\frac{1}{4}$ of said Section 1 to an intersection with the East and West center line of the Southwest $\frac{1}{4}$ of said Section 1:
3. Thence Westerly along the said East and West center line of the Southwest $\frac{1}{4}$ of said section 1 to an intersection with the West line of said Section 1:
4. Thence Northerly along the said West line of said Section 1 to an intersection with the East and West center line of the Northeast $\frac{1}{4}$ of section 2, Township 14 South, Range 4 West, S.B.M.:
5. Thence Westerly along the said East and West center line of the Northeast $\frac{1}{4}$ of said Section 2 to an intersection with the West line of said Northeast $\frac{1}{4}$ of said Section 2:
6. Thence Northerly along the said West line of the Northeast $\frac{1}{4}$ of said Section 2 to an intersection with the North line of said section 2.
7. Thence continuing Northerly along the North and South center line of section 35, Township 13 South, Range 4 West, S.B.M., to an intersection with the East and West center line of the Southwest $\frac{1}{4}$ of said Section 35.

-2-

8. Thence westerly along the said East and West center line of Southwest $\frac{1}{4}$ of said section 35 to an intersection with the West line of said section 35:
9. Thence continuing Westerly along the North line of Lot A of fractional section 34, Township 13 South, Range 4 West, S.B.M. to an intersection with the line of the Mean High Tide of the Pacific Ocean:
10. Thence Northwesterly along the said line of the Mean High Tide of the Pacific Ocean to its intersection with the North line of said fractional section 34:
11. Thence Easterly along the North line of said fractional section 34 to a point distant 50 feet westerly from and measured at right angles to the center line of the main track of the Atchison, Topeka & Santa Fe Railway Company:
12. Thence Southerly parallel to and distant 50 feet ^{Northerly} from and measured at right angles to the center line of the said main track to a point on the East and West center line of the North half of said fractional Section 34:
13. Thence Easterly along the said East and West center line of the North half of said fractional Section 34 to the East line of said fractional section 34:
14. Thence continuing Easterly along the East and West center line of the North half of Section 35, Township 13 South, Range 4 West, S.B.M. to an intersection with the North and South center line of the Northeast $\frac{1}{4}$ of said Section 35:
15. Thence Southerly along the said North and South center line of the Northeast $\frac{1}{4}$ of said Section 35 to an intersection with the South line of the said Northeast $\frac{1}{4}$ of said Section 35:

- 16. Thence Easterly along the said South line of the Northeast $\frac{1}{4}$ of said Section 35 to an intersection with the East line of said Section 35:
- 17. Thence Northerly along the said East line of said section 35 to an intersection with the East and West center line of the North half of section 36, Township ~~13~~ South, Range 4 West, S.B.M:
- 18. Thence Easterly along the said East and West center line of the North half of said section 36 to an intersection with the East line of said section 36:
- 19. Thence Southerly along the said East line of said Section 36 to an intersection with the South line of Lot 2 of fractional Section 31, Township 13 South Range 3 West, S.B.M:
- 20. Thence Easterly along the said South line of said Lot 2 to the Southeast corner of said Lot 2.
- 21. Thence Northerly along the East line of said Lot 2 to an intersection with the Westerly boundary line of the Rancho San Dieguito as said boundary line is shown upon map thereof in Book 1, Page 37, records of San Diego County, California, and filed in the office of the Clerk of said County October 25, 1875:
- 22. Thence Northerly, Easterly and Southerly along the boundary line of said Rancho San Dieguito to an intersection with the ~~South~~^{North} line of fractional Section 27, Township 13 South Range 3 West, S.B.M:
- 23. Thence Easterly along the said ~~South~~^{North} line of said fractional Section 27 to the ~~Southeast~~^{Northwest} corner of said fractional Section 27:
- 24. Thence Southerly along the East line of ~~fractional Section 27,~~^{said} Township ~~13 South, Range 3 West, S.B.M:~~ to the Southeast corner of said

fractional Section 27:

- 25. Thence continuing Southerly along the East line of fractional Section 34, Township 13 South, Range 3 West, S.B.M. to an intersection with the East and West center line of the Northeast $\frac{1}{4}$ of said Fractional Section 34:
- 26. Thence Westerly along the said East and West center line of said Northeast $\frac{1}{4}$ of said Fractional Section 34 to an intersection with the ~~East line of Lot 1 of said Fractional Section 34:~~^{boundary line of the aforesaid Rancho San Dieguito.}
- 27. ~~Thence continuing Westerly along the South line of said Lot 1 of said Fractional Section 34 to an intersection with the Easterly boundary line of the said Rancho San Dieguito:~~
- 28. Thence Southerly and Southwesterly along the boundary line of said Rancho San Dieguito to an intersection with the East line of Lot 2 of Fractional Section 4, Township 14 South, Range 3 West, S.B.M:
- 29. Thence Southerly along the said East line of said Lot 2 to the Southeast corner of said Lot 2:
- 30. Thence Westerly along the South line of said Lot 2, to a point on the Southeasterly boundary line of the said Rancho San Dieguito, said point being also the most Easterly corner of the Maggie Branson Lot as said lot is shown on the aforesaid Map of the Rancho San Dieguito on file ^{California.} in Book 1, Page 37, records of San Diego County, filed in the office of the Clerk of said County:
- 31. Thence continuing Westerly along the Northerly line of the said Maggie Branson Lot to an intersection with the Southwesterly boundary line of the said Rancho San Dieguito:
- 32. Thence along the said Southwesterly boundary line of the said Rancho San Dieguito to an intersection with the East line of Fractional

Section 6, Township 14 South, Range 3 West, S.B.M:

33. Thence Southerly along the said East line of said Fractional Section 6 to a point, said point being the most Northeasterly corner of that certain tract of land conveyed by Carl A. Sinke to the Santa Ana ~~Co-operative~~ ^{Co-operative} Sugar Co. by deed recorded Oct. 3, 1913, in Book 613, Page 327 of Deeds, Records of San Diego County, California.

34. Thence in a general Westerly direction along the Northerly line of said tract so conveyed to the said Santa Ana ~~Co-operative~~ ^{Co-operative} Sugar Co. to a point on the West line of the Southeast $\frac{1}{4}$ of said fractional Section 6, Township 14 South, Range 3 West, S.B.M., said point being also the most Northeasterly corner of that certain tract of land conveyed to the County of San Diego by Ed Fletcher and Mary C.B. Fletcher, husband and wife by deed recorded Dec. 21, 1921 in Book 751, Page 240 of Deeds, Records of San Diego County, California.

35. Thence in a general Southwesterly direction along the Northern boundary line of that said tract so conveyed by said Ed Fletcher and Mary C.B. Fletcher to the said County of San Diego, California, to an intersection with the East and West center line of the Southwest $\frac{1}{4}$ of said fractional Section 6, Township 14 South, Range 3 West, S.B.M:

36. Thence Westerly along the said East and West center line of said Southwest $\frac{1}{4}$ of said fractional Section 6 to an intersection with the West line of said fractional Section 6:

37. Thence Northerly along the said West line of said fractional ^{Said line being also the Range line between Range 3 West and Range 4 West S.B.M} Section 6 to an intersection with the East and West center line of Section ^{S.B.M} 1, Township 14 South, Range 4 West and the point of beginning.

DESCRIPTION OF THE EXTERIOR BOUNDARY OF THE PROPOSED SANTA FE IRRIGATION DISTRICT.

Beginning at a point on the Range Line between Range 3 West and Range 4 West, S.B.M. formed by the intersection of the said Range line with the East and West center line of Section 1, Township 14 South, Range 4 West, S.B.M;

Thence Westerly along the said East and West center line of said Section 1 to an intersection with the North and South center line of the Northeast $\frac{1}{4}$ of the Southwest $\frac{1}{4}$ of said Section 1;

Thence Southerly along the said North and South center line of the Northeast $\frac{1}{4}$ of the Southwest $\frac{1}{4}$ of said Section 1 to an intersection with the East and West center line of the Southwest $\frac{1}{4}$ of said Section 1;

Thence Westerly along the said East and West center line of the Southwest $\frac{1}{4}$ of said section 1 to an intersection with the West line of said Section 1;

Thence Northerly along the said West line of said Section 1 to an intersection with the East and West center line of the Northeast $\frac{1}{4}$ of section 2, Township 14 South, Range 4 West, S.B.M.;

Thence Westerly along the said East and West center line of the Northeast $\frac{1}{4}$ of said Section 2 to an intersection with the West line of said Northeast $\frac{1}{4}$ of said Section 2;

Thence Northerly along the said West line of the Northeast $\frac{1}{4}$ of said Section 2 to an intersection with the North line of said section 2;

Thence continuing Northerly along the North and South center line of section 35, Township 14 South, Range 4 West, S.B.M., to an intersection with the East and West center line of the Southwest $\frac{1}{4}$ of said Section 2

Thence westerly along the said East and West center line of Southwest $\frac{1}{4}$ of said section 2 to an intersection with the West line of said section 35;

Thence continuing Westerly along the North line of Lot 4 of fractional section 34, Township 14 South, Range 4 West, S.B.M. to an intersection with the line of the Mean High Tide of the Pacific Ocean;

Thence Northwesterly along the line of the Mean High Tide of the Pacific Ocean to its intersection with the North line of said fractional section;

Thence Easterly along the North line of said fractional section 34 to a point distant 50 feet westerly from and measured at right angles to the center line of the main track of the Atchafalaya

Topeka & Santa Fe Railway Company;

- Thence Southerly parallel to and distant 50 feet Westerly from and measured at right angles to the center line of the said main track to a point on the East and West center line of the North half of said fractional Section 34;
- Thence Easterly along the said East and West center line of the North half of said fractional Section 34 to the East line of said fractional section 34;
- Thence continuing Easterly along the East and West center line of the North half of Section 35, Township 13 South, Range 4 West, S.B.M. to an intersection with the North and South center line of the Northeast $\frac{1}{2}$ of said Section 35;
- Thence Southerly along the said North and South center line of the Northeast $\frac{1}{2}$ of said Section 35 to an intersection with the South line of the said Northeast $\frac{1}{2}$ of said Section 35;
- Thence Easterly along the said South line of the Northeast $\frac{1}{2}$ of said Section 35 to an intersection with the East line of said Section 35;
- Thence Northerly along the said East line of said section 35 to an intersection with the East and West center line of the North half of section 36, Township 13 South, Range 4 West, S.B.M.;
- Thence Easterly along the said East and West center line of the North half of said section 36 to an intersection with the East line of said section 36;
- Thence Southerly along the said East line of said Section 36 to an intersection with the South line of Lot 2 of fractional Section 31, Township 13 South Range 3 West, S.B.M.;
- Thence Easterly along the said South line of said Lot 2 to the Southeast corner of said Lot 2;
- Thence Northerly along the East line of said Lot 2 to an intersection with the Westerly boundary line of the Rancho San Dieguito as said boundary line is shown upon map thereof in Book 1, Page 37, records of San Diego County, California, and filed in the office of the Clerk of said County, October 25, 1875;
- Thence Northerly, Easterly and Southerly along the boundary line of said Rancho San Dieguito to an intersection with the North line of fractional Section 27, Township 13 South, Range 3 West, S.B.M.;
- Thence Easterly along the said North line of said fractional Section 27 to the Northeast corner of said fractional Section 27;
- Thence Southerly along the East line of said fractional Section 27, to the Southeast corner of said fractional Section 27;

- Thence continuing Southerly along the East line of fractional Section 34, Township 13 South, Range 3 West, S.B.M. to an intersection with the East and West center line of the Northeast $\frac{1}{2}$ of said Fractional Section 34;
- Thence Westerly along the said East and West center line of said Northeast $\frac{1}{2}$ of said Fractional Section 34 to an intersection with the Easterly boundary line of the aforesaid Rancho San Dieguito;
- Thence Southerly and Southwesterly along the boundary line of said Rancho San Dieguito to an intersection with the East line of Lot 2 of Fractional Section 4, Township 14 South, Range 3 West, S.B.M.;
- Thence Southerly along the said East line of said Lot 2 to the Southeast corner of said Lot 2;
- Thence Westerly along the South line of said Lot 2, to a point on the Southeasterly boundary line of the said Rancho San Dieguito, said point being also the most Easterly corner of the Maggie Branson Lot as said lot is shown on the aforesaid Map of the Rancho San Dieguito on file in Book 1, Page 37, records of San Diego County, California, filed in the office of the Clerk of said County;
- Thence continuing Westerly along the Northerly line of the said Maggie Branson Lot to an intersection with the Southwesterly boundary line of the said Rancho San Dieguito;
- Thence along the said Southwesterly boundary line of the said Rancho San Dieguito to an intersection with the East line of Fractional Section 6, Township 14 South, Range 3 West, S.B.M.;
- Thence Southerly along the said East line of said Fractional Section 6 to a point, said point being the most Northeasterly corner of that certain tract of land conveyed by Carl A. Sinke to the Santa Ana Co-operative Sugar Co. by deed recorded Oct. 3, 1913, in Book 613, Page 327 of Deeds, Records of San Diego County, California.
- Thence in a general Westerly direction along the Northerly line of said tract so conveyed to the said Santa Ana Co-operative Sugar Co. to a point on the West line of the Southeast $\frac{1}{4}$ of said fractional Section 6, Township 14 South, Range 3 West, S.B.M., said point being also the most Northeasterly corner of that certain tract of land conveyed to the County of San Diego by Ed Fletcher and Mary C. B. Fletcher, husband and wife, by deed recorded Dec. 21, 1921 in Book 751, Page 240 of Deeds, Records of San Diego County, California.
- Thence in a general Southwesterly direction along the Northern boundary line of that said tract so conveyed by said Ed Fletcher and Mary C. B. Fletcher to the said County of San Diego, California, to an intersection with the East and West center line of the Southwest $\frac{1}{4}$ of said fractional Section 6, Township 14 South,

January 6, 1934.

Range 3 West, S.B.M.;

Thence Westerly along the said East and West center line of said Southwest $\frac{1}{4}$ of said fractional Section 6 to an intersection with the West line of said fractional Section 6;

Thence Northerly along the said West line of said fractional Section 6, said line being also the Range line between Range 3 West and Range 4 West, S.B.M., to an intersection with the East and West center line of Section 1, Township 14 South, Range 4 West, S.B.M. and the point of beginning.

Board of Directors,
Santa Fe Irrigation District,
Rancho Santa Fe, California.

Gentlemen:

I am submitting below information relating to application of this District for a loan from the Reconstruction Finance Corporation and the present status thereof:

1. - History of Application and Purpose of Loan.

Application was filed with the R. F. C. in August, 1933 and requests a loan of \$525,000 for the purpose of refunding the District's present bonded indebtedness of \$700,000 on the basis of 75¢ on the dollar. The present bonds mature serially 1933-1952 and bear interest at 6%. If the loan were granted the present bondholders would relinquish their bonds for 75% of the face value cash, and the District would issue new bonds for the amount of the loan and deposit same with the R. F. C. as security for the loan. The new bonds would mature serially 1938-1971 and would bear interest at the rate of 4%.

2. - Consideration of Loan Application by R. F. C.

Engineering, legal and financial studies of the application have been pursued by the Division of Irrigation, Drainage and Levee Districts of the R. F. C. of which Emil Schram is Chief, Frank J. Keenan, Financial Advisor. Former Senator J. J. Blaine of Wisconsin, member of the Board of Directors of the R. F. C., has direct supervision over this Division.

An appraisal of the District was made in November, 1933 by an appraiser of this Division of the R. F. C. He checked carefully the District's physical property charges per acre and the District's present financial situation, and interviewed personally six land owners in the District. It is understood that the appraiser in his report recommended a loan of \$420,000, or on the basis of 60¢ on the dollar, and reported favorably on the District's need for refinancing and the security of the loan. It is also understood that subsequently the engineering and legal advisors of the Division reported favorably on the District's application.

The refunding of the District's bonded indebtedness on the basis of 60¢ on the dollar, as recommended by the appraiser would result in savings to the District through reduction in interest and principal payments of \$40,000 annually.

3. - Additional Information Furnished by District.

Subsequent to the filing of original application additional information has been presented to the Division relating to charges per acre, State and County taxes, modification of water contract, and the District's financial position. The District's attorney has been in Washington in connection with other matters and has kept in touch with officials of the Division in furtherance of securing favorable action on the District's application. When it appeared the Financial Advisor of the Division lacked a clear understanding of the District's financial situation, charges per acre, plan of development, and extent and type of development, I was authorized to present to the Financial Advisor, personally in Washington, such additional facts and information as might be necessary to remove any doubt about the District's financial situation, the need for financial relief and the prospects for repayment of the loan.

4. - Objections of Financial Advisor.

(a) The Financial Advisor hesitated to recommend the loan because of the small area planted, - only 3,000 acres of 10,000 acres in the District. It was pointed out to him that of the 10,000 acres, less than 7,000 acres was classified as irrigable land suitable for cultivation; that of the 10,000 acres, approximately 7,000 acres was in small holdings, each partially or wholly planted; that each individual land owner was making every effort to pay the assessments and charges on the entire holding in order to protect the investment in the portion planted; that the assessments and charges were levied against the parcel as a whole and could not be separated as between the area planted and the area not planted; that therefore the developed area should be considered as being 7,000 acres instead of only 3,000 acres and that by no means should it be assumed that only one corner of the District containing 3,000 acres was planted solid and the balance of the District was entirely undeveloped.

In this connection it should be noted here that the District assessments and water charges are levied against the non-irrigable lands to the extent of only 25% of that levied against the irrigable lands. The full burden of assessments and water charges is therefore assumed by all of the irrigable land and by one-fourth of the non-irrigable land or by a total of 7,424 acres.

(b) The Financial Advisor was concerned about the large blocks of unsold and undeveloped lands, particularly from a revenue standpoint. It was pointed out to him that of the 3,000 acres of unsold land, approximately 1,500 acres were held by the Santa Fe Land Improvement Co. who were paying all assessments and charges and would continue to do so, and approximately 1,500 acres were held by the Rancho Solana Corporation who were one and one-half years delinquent in payment of assessments and charges; that in the latter case a mortgage

of \$450,000 was held by the Whitney Estate of New York against the property, that the mortgage was in default, and that the District was making an effort to have the Whitney Estate foreclose on the mortgage, liquidating the delinquent assessments and charges.

In this connection it should be noted here that of the unsold lands of approximately 3,000 acres, only about 1,900 acres are classified as agricultural irrigation land and of this area several hundred acres are in valleys not suitable for semi-tropical fruit culture. Thus it is readily apparent that the most desirous of the land in the District has been sold and is now held in small ownerships.

(c) The Financial Advisor considered the charges per acre too high (particularly according to his method of allocating the total District charges over the 3,000 acres of planted land only - about \$60.00 per acre). It was pointed out to him that the District charges should be spread over at least 7,000 acres, being the area included in individual holdings, partially or totally developed, and that from a revenue standpoint, might be spread over 8,500 acres, considering the fact that the Santa Fe Land Improvement Co. was paying all assessments and charges on the 1,500 acres of undeveloped land they still owned. In any event the full burden of assessments and water charges is carried by 7,424 acres in the District whether developed or undeveloped, planted or unplanted and spread over this area the annual charges amount to only \$24 per acre, the lowest charges per acre of any irrigation district in San Diego County and favorable when compared with most agricultural areas in Southern California. Under the proposed plan of refinancing these charges would be reduced to less than \$19 per acre. The Financial advisor is apparently unfamiliar with farming operations and water costs in Southern California. It was therefore pointed out to him that the charges in our District were not exorbitant considering the value per acre of crops produced and the long growing season in Southern California as compared with other agricultural areas throughout the Country.

(d) The Financial Advisor considered that an insufficient number of people would be effected by the granting of this loan as compared with other districts, pointing out that the District's population was only 800. It was explained that more than half of the District's land owners were non-resident, had purchased the property several years ago and planted orchards with the hope that as the orchards would mature and become income producing, they would establish permanent homes in the District. The change in economic conditions brought about by the 1929 financial collapse, and the low prices prevailing for agricultural products has temporarily frustrated these plans. Considering all of the property owners in the District, a population of about 2,500 would be benefited by the proposed refinancing.

(e) The Financial Advisor took the position that the financial distress in the District was not severe and did not warrant the R. F. C. refinancing. He argued that the non-resident

1/6/34

owners had established homes in various parts of the Country and no doubt enjoyed income from sources other than their orchards in the Santa Fe Irrigation District, that therefore these owners would suffer no serious loss nor human misery if forced to sacrifice their holdings in the Santa Fe Irrigation District; furthermore, that a return of normal or even semi-normal conditions in the near future will enable these land owners to meet the payment of present delinquent assessments and charges and continue to meet future District obligations on the present basis of indebtedness. He also argued that an analysis of owners in the District indicated that the distress could not be considered acute, and that it was not the policy of the government to make loans to Districts in which there were owners such as Douglas Fairbanks and others who by themselves were financially able to arrange the refinancing requested. It was pointed out to him that the financial relief afforded by the proposed refinancing could by no means be considered direct relief, that it was merely another step toward reducing the debt burden of the Country and relieving the tax burden on real estate, over-burdened for many years; that the wording of the Agricultural Emergency Act indicated that this was the purpose and intent of this form of refinancing, and that therefore, in considering loan applications, the government should confine its examination - first, to the necessity for refinancing according to record of defaults in meeting bond interest and principal and extent of assessment delinquencies; second, the assurance of an agreement by the bondholders to accept cash in lieu of their bonds according to the amount of loan recommended, and; third, the security of the loan, feasibility of project, plan of development. It was also pointed out to him that there were but very few owners of financial importance in the District, such as Douglas Fairbanks; that these few owners had already made large investments in the District, could not be expected to carry the burden of the entire District, and that they represented important assets to the District from the standpoint of present and future developments; also, that if a refinancing of the District's obligations was not accomplished and assessment delinquencies continued, the additional burden thrust upon the lands which are not delinquent would be prohibitive from a farm operation standpoint. The result would be complete failure of the District and the loss of \$15,000,000 invested in land, orchards, and operative property.

5. - Present Status of Application.

Notwithstanding all of the arguments presented in support of our contention that the application of this District for a refunding loan from the R. F. C. fully meets the requirements, and is fully in accord with the intent and purposes of Section 36, Part 4 of the Emergency Farm Mortgage Act of 1933 as amended, recent wire communication from our attorney indicates that the Financial Advisor has reported adversely on our application upon the grounds of no distress. Our attorney has arranged that the report be withheld pending the presentation of additional facts and information before final action by the Board of Directors of the R. F. C. is taken. This information is now being assembled.

1/6/34

6. - Conclusions.

It is recommended that additional information be furnished the Financial Advisor as follows:

(a) A map showing ownership of every parcel of land in the District, except town-site property, and stating acreage owned, acreage planted, and segregating by colors, the areas of unsold land.

(b) Additional evidence to justify the reasonableness of the charges per acre by making comparison of gross value of crops produced in the District with the gross value of crops produced in other sections of the country where lower water charges per acre prevail.

(c) Additional evidence to show conclusively the steadily increasing distress in the District, including a statement of the assessment delinquencies for the six months period ending December 25th, 1933, which amounted to 68.7% as compared with 44.7% for 1932, 27.6% for 1931 and 5.7% for 1930.

It is also recommended our local Representative in Congress and the Senators from California be requested to join in a cooperative effort to secure a reconsideration of the District's application by the Financial Advisor in view of the additional data presented in support of the District's application, and with the thought of impressing further upon the Financial Advisor the merits of the District's application, and of correcting his apparent misconception of conditions in Southern California.

It is also recommended that other persons who may be of assistance be supplied with information regarding the District's financial situation and the status of the District's loan application.

Yours very truly,

WOB:B

Secretary-Manager.

Ed Fletcher Papers

1870-1955

MSS.81

Box: 48 Folder: 10

Business Records - Water Companies - Volcan Land and Water Company - San Dieguito System - Santa Fe Land Improvement Company/Santa Fe Irrigation District - Santa Fe Irrigation District - Miscellaneous



Copyright: UC Regents

Use: This work is available from the UC San Diego Libraries. This digital copy of the work is intended to support research, teaching, and private study.

Constraints: This work is protected by the U.S. Copyright Law (Title 17, U.S.C.). Use of this work beyond that allowed by "fair use" requires written permission of the UC Regents. Permission may be obtained from the UC San Diego Libraries department having custody of the work (<http://libraries.ucsd.edu/collections/mscl/>). Responsibility for obtaining permissions and any use and distribution of this work rests exclusively with the user and not the UC San Diego Libraries.